

Pro-Series 8000i Artemis

RDS Part No.:	S/DC/500-10-566
Document Issue:	2.2 : 27.1.12
Software Issue:	PS405-001 rev 27

Electromagnetic Compatibility (EMC)



This product complies with Council Directive 2004/108/EEC when installed and used in accordance with the relevant instructions.

IMPORTANT, READ THIS BEFORE USING THE PS ARTEMIS

The Pro-Series Artemis installation is a part of the Precision Farming System ("the System"). It is very important that you follow the described calibration procedures before operating the Pro-Series Artemis instrument. Calibration and operation of the Pro-Series Artemis must be in accordance with these instructions. Use of the System is subject to the following disclaimer;

1. So far as is legally permissible RDS Technology ("RDS"), or its distributors, shall not be liable, whatever the cause, for any increased costs, loss of profits, business, contracts, income, or anticipate savings or for any special, indirect or inconsequential damage whatsoever (death or personal injury excluded).
2. The capabilities and functions of the Precision Farming System ("the System") are limited as set out in the specification of the System, details of which are contained in the Help files and product literature and which must be read before using the System.
3. Without prejudice to the generality of the above it is hereby acknowledged that the System is not designed nor intended to a) originate variable treatment plans or b) achieve or avoid any application rate outside application parameters, which in both cases shall be the responsibility of the operator.
4. The standard terms and conditions of RDS (except clause 7), a copy of which is available on request, apply to the supply and operation of this System.

Service and Technical Support

PLEASE CONTACT YOUR NEAREST RDS DISTRIBUTOR If unknown then contact RDS Technology Ltd for further information,

Tel : +44 (0) 1453 733300

Fax : +44 (0) 1453 733311

e-mail : info@rdstec.com

web : www.rdstec.com

Our policy is one of continuous improvement and the information in this document is subject to change without notice. Check that the software reference matches that displayed by the instrument.

© Copyright RDS Technology Ltd 2012

UK566220.DOC

1.	OVERVIEW	4
1.1	The Artemis system (dual motors)	4
1.2	Main functions	5
1.3	Control Modes and Data Logging	6
	Automatic Control Mode	6
	VRT (Variable-rate treatment) Control Mode	6
1.4	Menu keys	6
2.	OPERATION	7
2.1	Status Indicators	7
2.2	'MAIN' screen	7
	2.2.1 Forward speed display and alarm functions	8
	Display smoothing	8
	Speed alarms on MAIN screen	8
	Maximum speed reminder	9
	2.2.2 Tramlining status/functions	9
	2.2.3 Advancing the bout number	9
	2.2.4 Holding the bout number	9
	2.2.5 Viewing Two Fan Speeds	10
	2.2.6 Area Cut Out	10
2.3	'RATE' screen	11
	2.3.1 Setting /overriding the target rate	11
2.4	'INFO' screen	12
2.5	Tramlining	12
2.6	Pre-start function	13
2.7	Metering motor – manual override/half-width drilling	14
2.8	Product calibration	14
	2.8.1 Initial product calibration	14
	2.8.2 'CALIBRATION NUDGE' - Adjusting the calibration factor	16
2.9	Set Fan Speed and Hopper Level alarm thresholds	16
2.10	Speed simulation	17
2.11	Select units / Rate step%	18
3.	DATA LOGGING AND VARIABLE RATE TREATMENT	19
4	ALARM CODES	20

1. Overview

1.1 The Artemis system (dual motors)

Figure 1

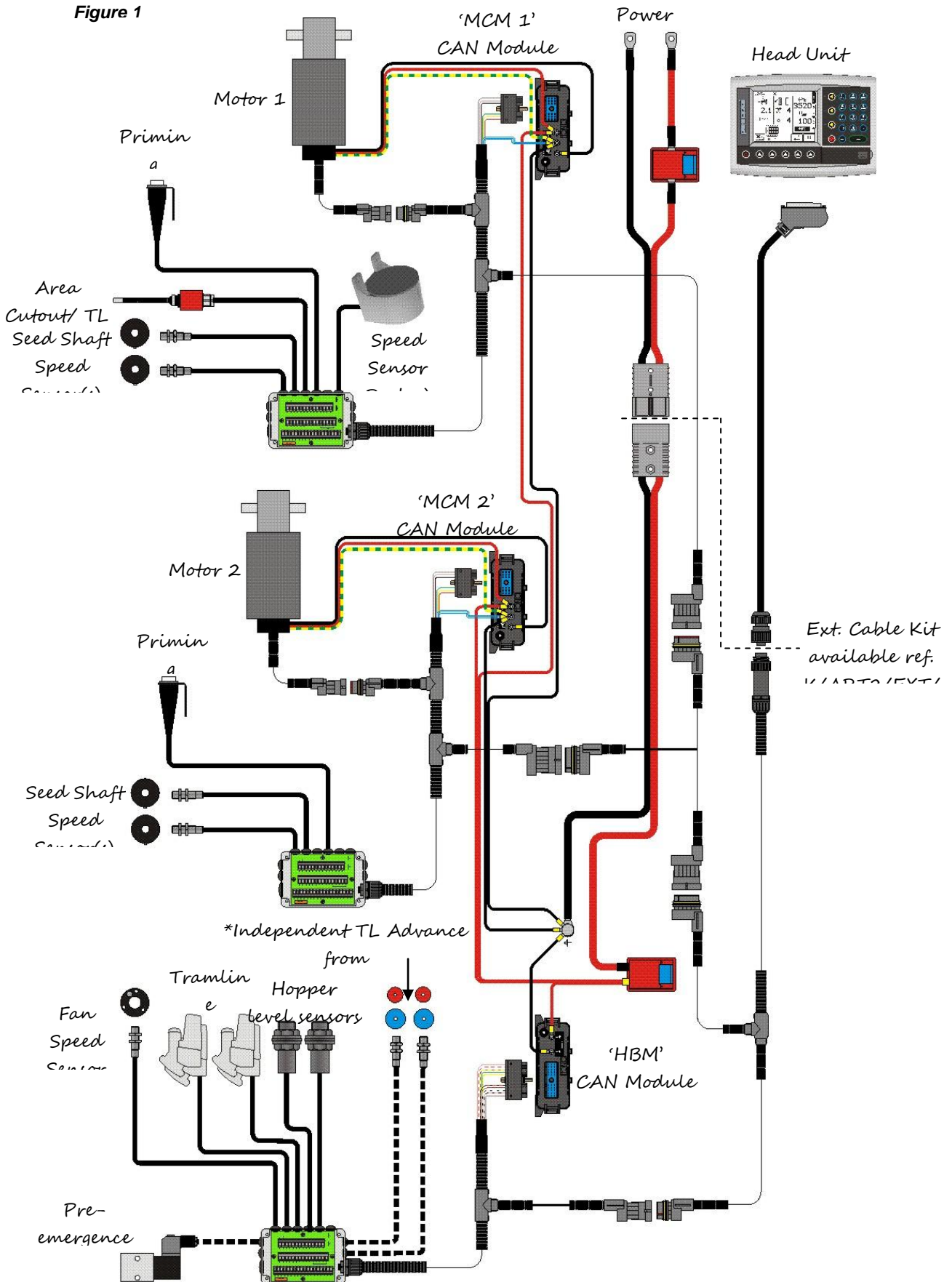





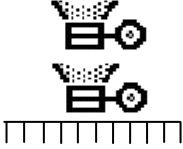
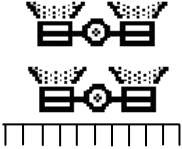

Figure 1 illustrates the various components of a typical, dual motor Artemis installation. Any of the following drill configurations (both single and dual motor) are possible, and the Artemis head unit can be configured accordingly.

PRODUCT	INSTRUMENT SETTING	METERING /MOTOR CONFIGURATION	INSTRUMENT SETTING
SEED		SINGLE MOTOR / METERING	
		SINGLE MOTOR / DUAL METERING	
		2 MOTORS / SINGLE METERING	
SEED + FERT		SINGLE MOTOR / METERING (SEED) + SINGLE MOTOR / METERING (FERT)	
		SINGLE MOTOR / DUAL METERING (SEED) + SINGLE MOTOR / DUAL METERING (FERT)	

Some screen pages vary slightly according to the instrument setup as shown above. Look for the above symbols next to the text.

1.2 Main functions

The Artemis is designed to allow automatic, variable rate control of any drill utilising Accord type metering units. You can at any time, also manually override the predetermined rate as field conditions require.

The basic functions are:

- Variable Rate Control
- Tramline Control
- Forward Speed Alarms
- Hopper Level alarm
- Fan Speed & alarm
- Information totals

The instrument has a special software routine that makes calibration of the metering unit(s) very easy. In the calibration mode each metering unit is controlled via a 'priming switch' to dispense the product (figure 1).

During normal operation the control system is started and stopped automatically via a magnetic sensor as the drill is put into and taken out of work. Depending on the particular installation, this sensor is triggered either by the operation of the landwheel or the markers.

1.3 Control Modes and Data Logging

Automatic Control Mode

The application rate is automatically regulated as forward speed varies, to ensure that the actual application rate constantly matches a preset target rate. The application rate can be manually nudged up and down from the target rate as required.

Field data ("job summaries") can be logged and are stored in the instrument memory. Up to 75 summaries can be stored. With a GPS receiver and SD data card, as well as creating a job summary, you can also log the vehicle route and application data to a "dynamic log" file on the SD card. The job summary data is also appended to this file.

VRT (Variable-rate treatment) Control Mode

This enables the system to be controlled via treatment instructions prepared using Precision Farming software in conjunction with DGPS position data. To enable fully automatic variable-rate treatment for Precision Farming applications, the PS 8000i requires a suitable DGPS receiver and a formatted SD data card to implement treatment plans generated in the Precision Farming software.

A work record file is automatically created on the card to log data confirming the actual treatment. The job summary data is also appended to this file, which can be viewed in the Precision Farming software

1.4 Menu keys

All instrument functions are accessed by nine menu keys adjacent to the LCD display.

Figure 1

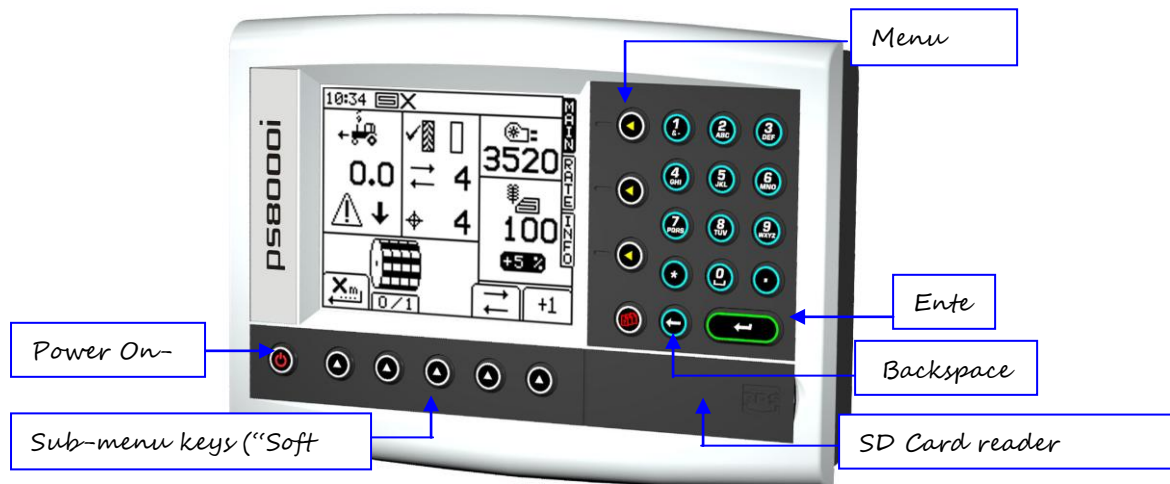

The four menu keys to the right of the screen (figure 1) access the primary screen pages (those viewed during normal operation). There are three primary screens MAIN, RATE and INFO for normal operating functions, and a SETUP screen for calibration functions.

The five sub-menu keys below the screen control the various display functions and settings for each of the primary screen pages. Text or icons are displayed adjacent to the sub-menu keys to denote their function.

2. Operation

2.1 Status Indicators

All the operating screens have a status bar at the top of screen displaying the time as well as a number of different icons. These icons indicate the following:

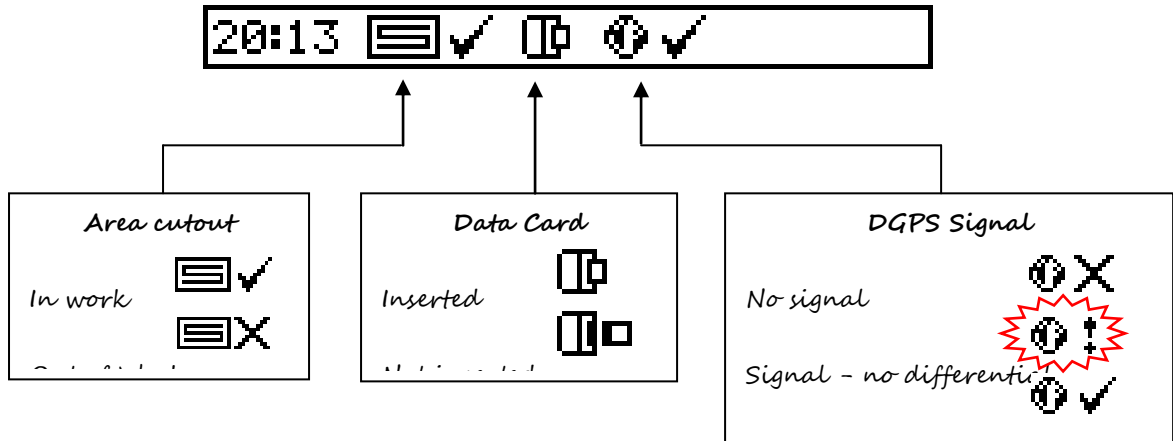

NOTE: The Data Card and GPS icons are only displayed when these functions are enabled via the SETUP menu.

2.2 'MAIN' screen

The instrument will always default to the MAIN screen on startup. The MAIN screen is divided into 5 sections displaying the following functions,

Figure 2: MAIN screen (single product / single metering)

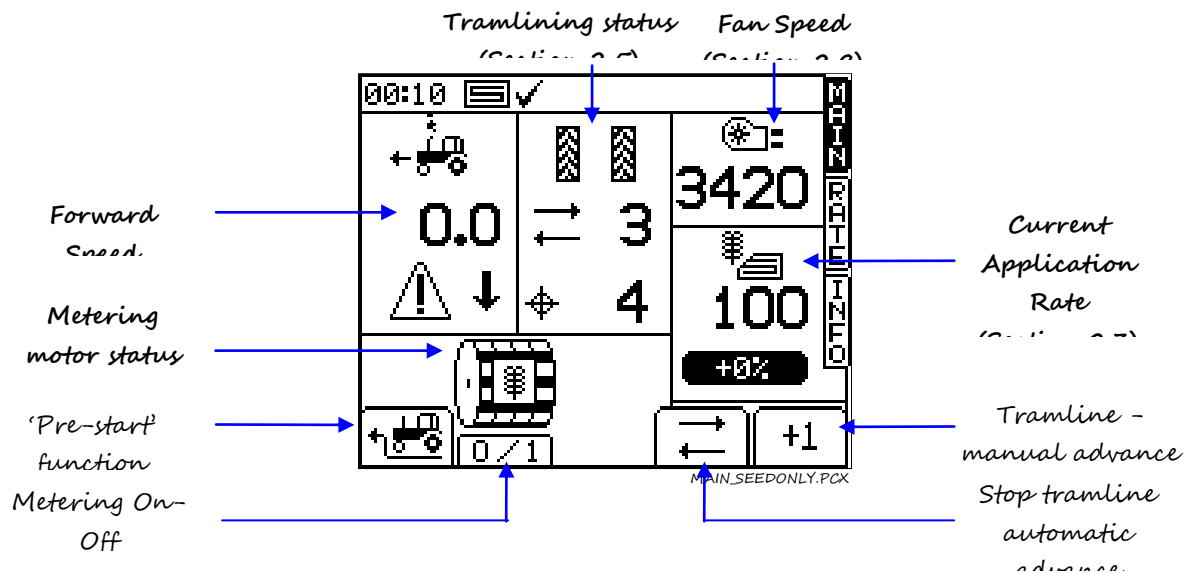

NOTE: The Metering motor status part of the display will appear differently depending on the drill configuration (ref. figures 3 and 4).

Figure 3: MAIN screen (dual product / single metering)

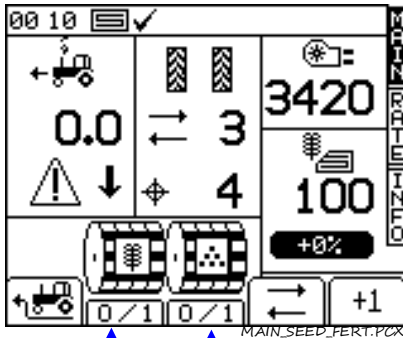

Display as figure 2 except as

Figure 4: MAIN screen (single product / dual metering)

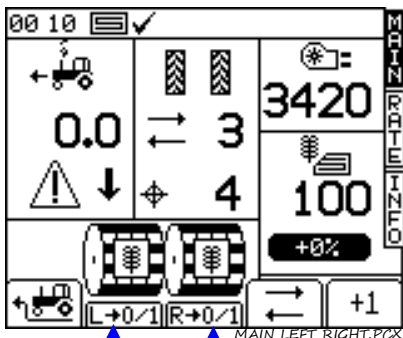

Display as figure 2 except as

2.2.1 Forward speed display and alarm functions

Display smoothing

Except for sudden changes in speed, the forward speed displayed at any moment will be the average speed calculated over 3 seconds.

Speed alarms on MAIN screen

The instrument is programmed with low and high forward speed alarms.

If the drill is in work and the speed is less than 0.5 km/h then this section of the MAIN display will flash the

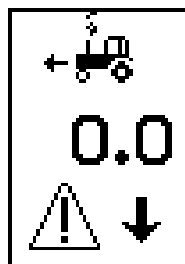

If the drill is in work and the speed is above the maximum that proportional control can achieve (indicated on the RATE screen), then this section of the MAIN

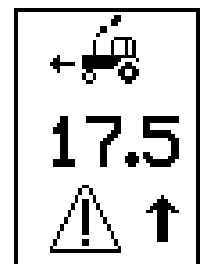

Maximum speed reminder

When setting a new target rate on the RATE screen, the instrument re-calculates and displays the maximum forward speed at which that rate can be maintained (fig.5). It is calculated from the rate set, drill working width, current calibration factor, gearbox ratio and maximum motor speed.

Figure 5

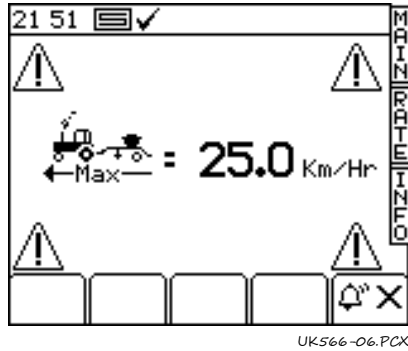

UK566-06.PCX

Simply press the  key to return to the RATE screen.

NOTE: If the speed is too low, the operator must open the metering unit and re-calibrate to increase the calibration factor (ref. the 'Calibration' manual).

2.2.2 Tramlining status/functions

The MAIN screen shows the current status of tramlining.

Tramline rhythm:-

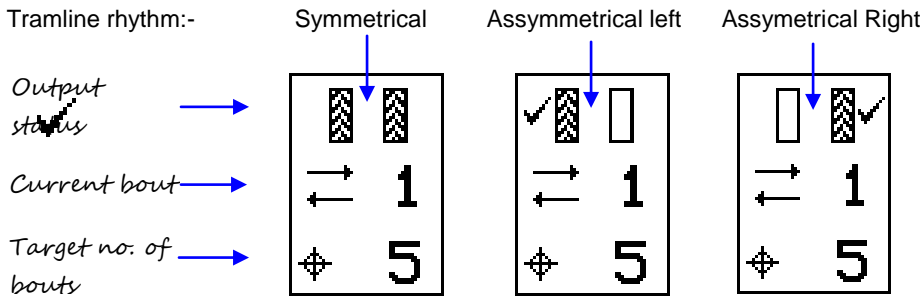

2.2.3 Advancing the bout number

On starting up the instrument the tramline sequence always starts at '1'.

If necessary, press the  key to select the correct current bout number, e.g. if entering work on a bout other than bout 1 of the tramline sequence.

2.2.4 Holding the bout number

Press the  key to hold the current bout number (e.g. to prevent the bout no. advancing if it is necessary to take the drill out of work, or depending on the drill setup - lift a marker, to negotiate a field feature).

The  icon indicates that the bout no. is held. Press the  key to resume normal bout advance.

NOTE: The tramlining sequence is set up via the SETUP page (ref. section 2.5).

2.2.5 Viewing Two Fan Speeds

If the instrument is configured to monitor two fan speeds, then the speeds display alternately in the fan speed section on the MAIN page.

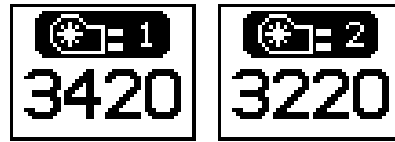

The two displays will automatically alternate between displaying each fan speed, however to view the second fan speed manually, simply press the MAIN button and the secondary fan speed will be displayed. Repeat this step to view Fan Speed 1 again.

The High and Low fan speed alarms will be active for both fans, using the settings as configured in the Alarm Setup (see section 2.9).

2.2.6 Area Cut Out

If the drill is lifted out of work then the 'out of work' the status is shown in the top box with a cross. The following is also shown for a second every 3 seconds as a reminder.



If this alarm is shown when the drill has been lowered in to work, then there is an issue with the setting of the finger switch used for area cut out. Check the switch and ensure that it has been activated, by the lowering of the drill.

2.3 'RATE' screen

This screen allows the drilling rate to be adjusted. Either kg/ha or seeds/m² units can be set via the SETUP menu.



Figure 6: RATE screen - single product

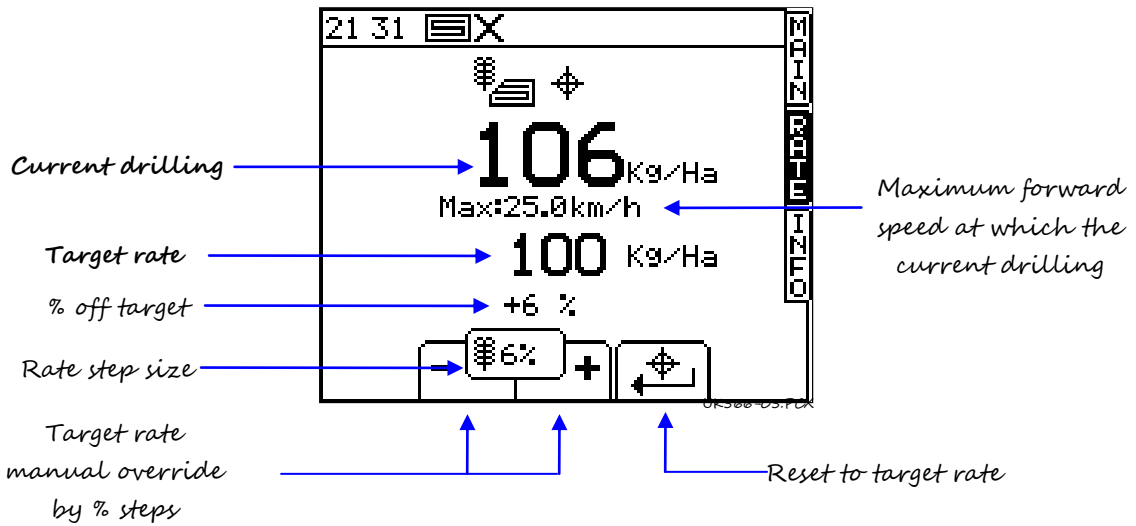
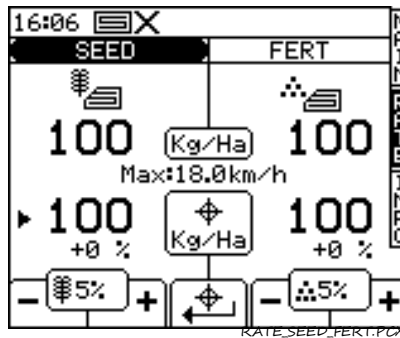

Figure 7: RATE screen - dual product



NOTE: The maximum forward speed shown is the lowest for the 2 products.

2.3.1 Setting /overriding the target rate

To set the target rate, simply enter the value and press the ENTER key to confirm.



To set the target rate or manually adjust the rate for either product, first press the ENTER key to select SEED or FERT.

The application rate on the MAIN screen is the same as that shown on the RATE screen above. If however on the rate screen, the current rate is manually adjusted above or below the target rate, then this number will flash (on for 1 second, off for 0.5 second).

When operating from a treatment plan, then this number should only flash if the instructed rate has been changed using the '+' or '-' percentage buttons on the rate screen.

To override the target rate, use the keys. The % step is configured from the SETUP menu.

To return to the target rate, press the key.

Both products are reset to their respective target rates

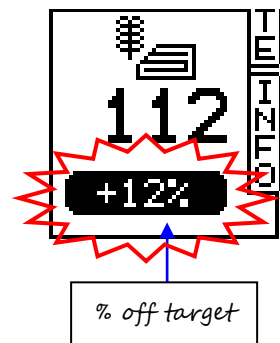

2.4 'INFO' screen

Figure 8

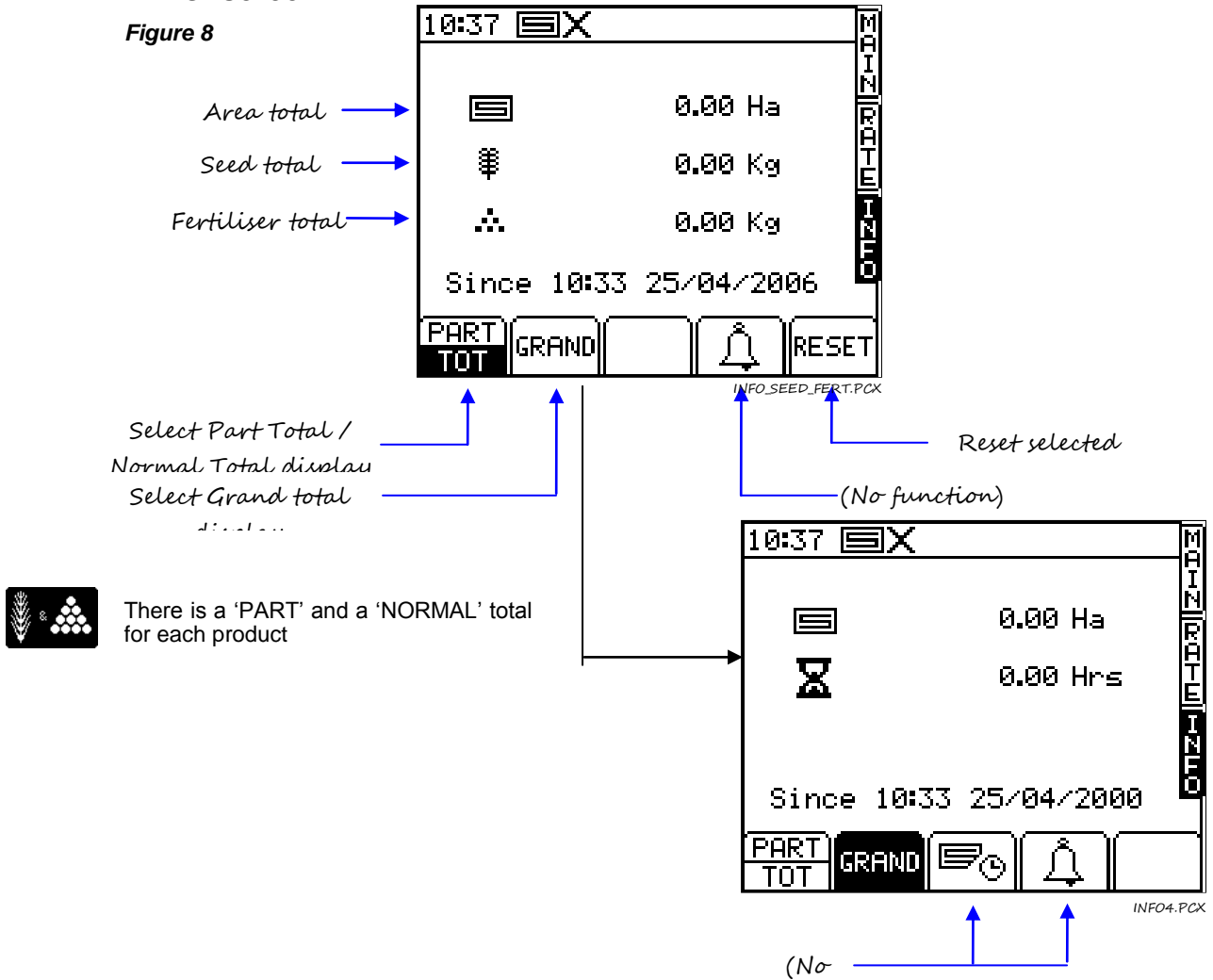

2.5 Tramlining

To set the desired tramline rhythm, select the SETUP screen and press the key.

Figure 9

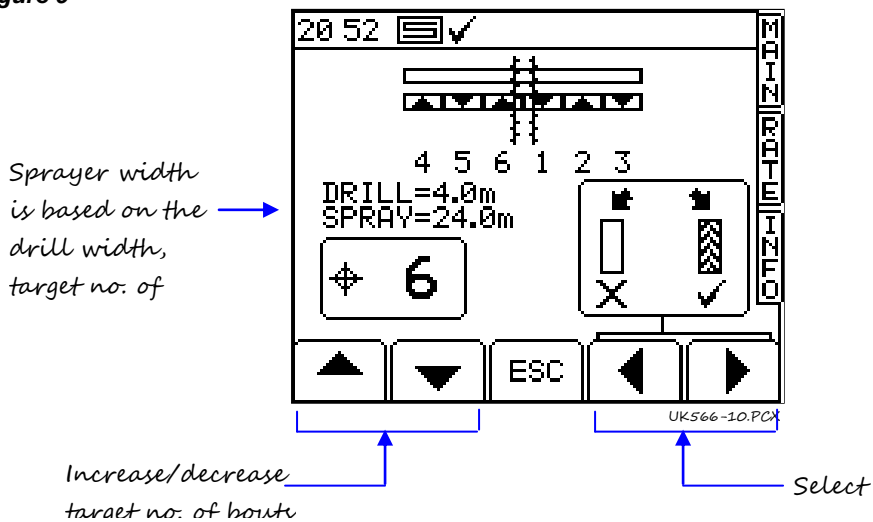

The target no. of bouts can be selected up to 20, with, symmetrical, asymmetrical left or asymmetrical right rhythm selectable.

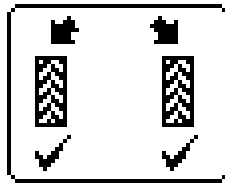

Symmetrical

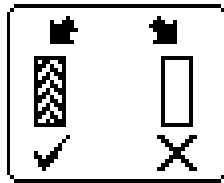

Asymmetrical left

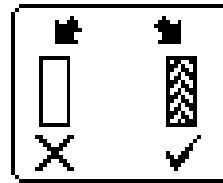

Asymmetrical right

The instrument displays the drill/sprayer width combination for the selected target no. of bouts.

Beyond 20 bouts, a number of special asymmetric rhythms can be selected to suit the following drill/sprayer width combinations.

- '8-pass' 4m drill/10.7m sprayer, 4.5m drill/12m sprayer
- '10-pass' 4m drill/10m sprayer, 6m drill/15m sprayer
- '10-pass' 4m drill/13.3m sprayer, 6m drill/20m sprayer
- '14-pass' 3m drill/14 sprayer, 4m drill/18.7m sprayer
- '16-pass' 4m drill/21.3m sprayer, 4.5m drill/24m sprayer
- '18-pass' 4m drill/18m sprayer
- '22-pass' 4m drill/29.3m sprayer

The tramline sequences ('L' – Left, 'R' – Right) are as follows:

Bout	8-pass	10-pass	10-pass	14-pass	16-pass	18-pass	22-pass
1							
2	R	R	L				
3				L	R	L	
4	L	L					L
5	L		R				
6			R				
7	R	L		R		R	
8				R	L		
9		R	L		L		
10							
11							R
12				L		R	R
13							
14					R		
15							
16						L	
17							
18							
19							L
20							
21							
22							

2.6 Pre-start function



Particularly useful in the case of a front-mounted hopper, the pre-start function helps to avoid an un-seeded area on entering work. It starts the metering unit at the calibration speed while the drill is still stationary, and 'primes' the drill so that the seed reaches the coulters just as the drill enters work.

The pre-start settings are established by trial and error tests when the system is first set up, and are adjusted via the calibration menu.

To use the pre-start feature, simply press the  key on the MAIN screen before moving off.

The metering motor will run at the calibration speed for a preset time limit, or until the forward speed exceeds 2km/hr, when full proportional control then takes over.

2.7 Metering motor – manual override/half-width drilling

Simply press the

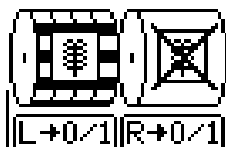

desired key(s).

The metering motor(s) can be stopped manually as desired, eg:

- An area of field needs further cultivation before seeding.
- In the case of a front-mounted hopper, the metering motor is switched off just before the end of the bout to clear the seed through (the opposite of the 'pre-start function').
- You want to drill at half-width.

NOTE: A reminder screen is shown every 10 seconds to remind the operator that the machine is at half width.

2.8 Product calibration

2.8.1 Initial product calibration

Set up the drill in the usual way for a bucket test.

- From the SETUP screen, press the  key.
- If the instrument is configured for dual products, first select the product you want to calibrate (fig.10).



Figure 10: Dual product/Single metering



NOTE: If carrying out product calibration from single motor, dual metering system, ensure that the product that is collected, weighed and programmed is from BOTH metering units.



- Or if configured for dual metering, select the metering unit to be calibrated (fig. 11).

Figure 11: Single Product/Dual metering



- Otherwise, select the desired units then enter the weight required to be metered out (fig.12) and press ENTER. The metering unit will then operate at the programmed calibration speed to dispense the correct amount of product, then stops. The instrument then displays a weight figure based on the existing programmed product calibration factor.

NOTE: If a priming switch is employed for calibration the calibration routine will commence from fig. 13.

4. Weigh the contents of the container, and then enter the *ACTUAL* weight dispensed (fig. 14) and press ENTER to confirm.

Figure 12

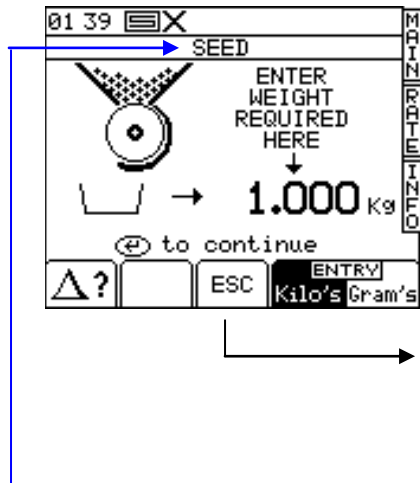

Figure 13

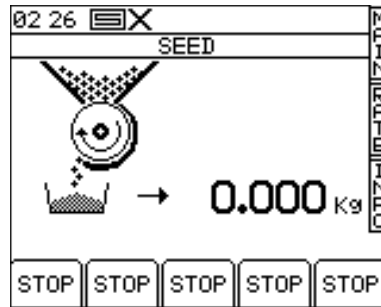
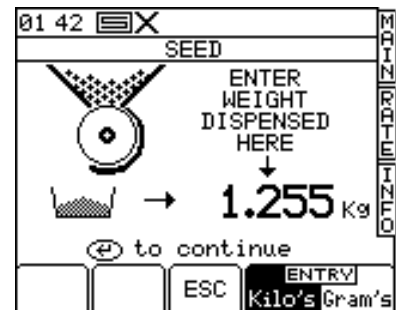

Figure 14



NOTE: The heading will be either SEED / FERT / LEFT / RIGHT according to steps 2a , 2b.

5. Press ENTER again for the instrument to re-calculate and display the new calibration factor in kg/rev, the error %, and the maximum forward speed that is permissible based on the application rate set for the product (fig.15).

Figure 15



6. Press ENTER again to confirm and store the new calibration factor, or press ESC to return to the SETUP menu screen.

It is recommended to reset the PART TOTAL to zero before commencing drilling. This will enable you after drilling an area, to quantify any error in the calibration factor by logging the theoretical amount of product used against a known amount used (a whole bag for example).

You can then adjust the calibration factor precisely, if necessary (section 2.5.2).

NOTE: Systems fitted to 'Accord' type metering mechanisms.

When changing from a low rate to a high rate i.e. 3kg/ha to 100kg/ha use the following procedure:

1. Move the metering slide to a position for the higher rate.
2. Operate the product calibration routine, dispense a suitable amount of product and enter the weight gained. The error will be considerable but press enter to correct the calibration factor and continue (see FIG 15).
3. Now program the required application rate (see SECTION 2.3).
4. Perform the product calibration routine again, the error this time will be marginal. Accept the error and begin drilling.

When changing from a high rate to a low rate i.e. 100kg/ha to 3kg/ha use the following procedure:



1. Move the metering slide to a position for the lower rate.
2. Operate the product calibration routine and enter the weight gained. If using the priming switch simply dispense a small amount of product and enter the weight. The error will be considerable but press enter to correct the calibration factor and continue (see FIG 15).
3. Now program the required application rate (see SECTION 2.3).

4. Perform the product calibration routine again this time dispensing a suitable amount of product. The error this time will be marginal. Accept the error and begin drilling.

2.8.2 'CALIBRATION NUDGE' - Adjusting the calibration factor

The 'calibration nudge' procedure enables you to adjust the existing calibration factor without having to redo a bucket test.

1. First note down the PART TOTAL for the product displayed in the INFO screen. This is the theoretical quantity that the instrument has calculated.

From the SETUP menu, press either the  key (CAL. CHECK), or the  key (DRILL SETUP).



If the instrument is configured for dual products, first select the product you want to calibrate (fig.10).



If configured for dual metering units, likewise, first select the left or right unit (fig.11)

2. From either screen, press the  key to select the 'Calibration Nudge' screen (fig.16).

Figure 16



Figure 17



Figure 18

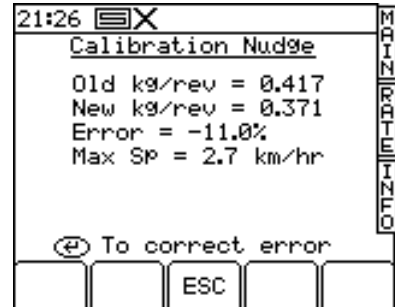

3. Enter the theoretical ('Expected') weight noted from the INFO screen at step 1 and press ENTER twice.
4. Enter the actual weight dispensed and press ENTER twice.
5. The cal factor is re-calculated and displayed along with the % error and maximum forward speed (fig.18). Press ENTER again to store the new factor.

2.9 Set Fan Speed and Hopper Level alarm thresholds

To view the alarm thresholds (fig. 19), from the SETUP menu, press the  key.

Figure 19



To adjust the threshold, simply enter the figure and press the ENTER key.

Note: If the system has been configured to use two fan sensors then the alarm figures will apply to both fans.

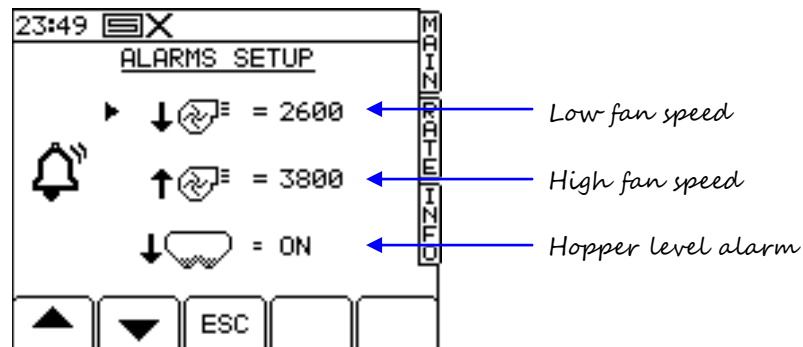

If the instrument is configured for dual products, the screen will display a level sensor for each product.

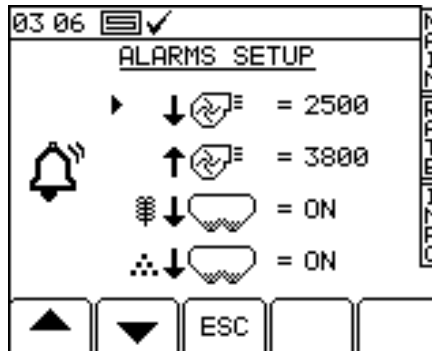

If the instrument is configured for single product, single motor and the Pre-Level sensor is enabled within the configuration, the screen will display a level sensor for the lower part of the tank but also a Pre-level hopper level sensor to act as an early warning.

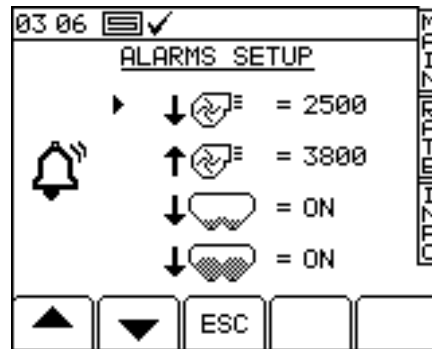

2.10 Speed simulation

If the radar speed sensor stops working, you can continue drilling by simulating a forward speed signal. Remember though that your actual forward speed should match the simulated speed as close as possible, otherwise the drilling rate will not be correct. Drive faster than the simulated speed and you will under-apply, and vice-versa.

To set the simulated forward speed, from the SETUP screen, select '1 User Setup' then '2. Speed Sensor Setup'.

Press the  key (fig.20), then enter the desired sim. speed (fig. 21).

Press the ENTER key again to start speed simulation.

Figure 20

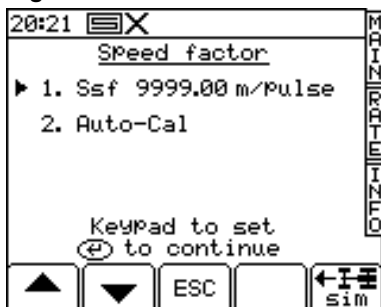
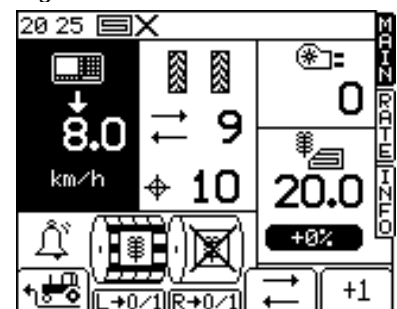

Figure 21



Figure 22



As long as speed simulation is running, the forward speed display on the MAIN screen will flash (fig. 22)

NOTE: The pre-start function works as normal with a simulated speed.

2.11 Select units / Rate step%

From the SETUP screen, select '1 User Setup' then '3. Customise'.

Figure 23

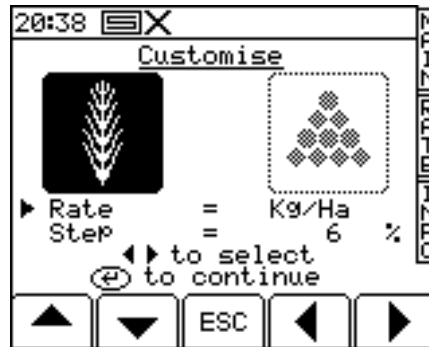

If the instrument is configured for dual products, first select the product with the LEFT/RIGHT arrow keys (fig.23).

Use the UP/DOWN arrow keys to select the parameter.

Use the LEFT/RIGHT arrow key to select the units (kg/ha or seeds/m²).

Use either the LEFT/RIGHT arrow keys to adjust the rate, or simply enter the desired figure using the keypad and press ENTER to confirm.

3. Data Logging and Variable Rate Treatment

Data Logging and Variable Rate control functions are accessed from the SETUP screen.

1. Press the  key to display the logging screen (fig. 24).
The instrument then detects the presence of the data card .
2. Press the START key to select the JOB STARTUP page (fig. 25).

Figure 24



Figure 25

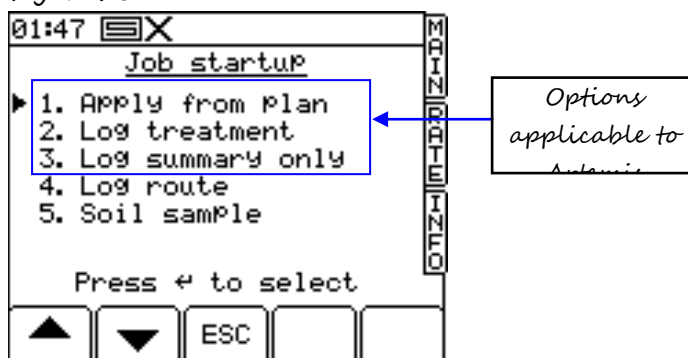

You are presented with a number of options. Only options 1,2 and 3 are applicable to the Artemis.

1. APPLY FROM PLAN (Variable-Rate Treatment or 'VRT')

- (a) The Pro-Series receives the rate from a treatment plan on the RDS Data Card Module and controls the application via the RDS control system. A full application record of the *actual* application is generated and saved on the Data Module.
- (b) The Pro-Series receives the rate from a treatment plan on the RDS Data Card Module and sends it to a third party controller, which controls the application via an OEM control system (System ERIS).
- (c) The Pro-Series receives the rate from a third-party controller and controls the application via the RDS control system (System ERIS). The Pro-Series can send back the actual application rate to the other controller

All setups allow the operator to commence a full VRT application.

For (a) and (b) a full application record of the *actual* application is generated and saved on the Data Module. The associated work record file can be viewed in the mapping/treatment plan software. Job summary data (iii) is also appended to the work record file.

2. LOG TREATMENT (Dynamic Data Logging)

A full application record is generated, logging rate and other parameters (e.g. "tags") in real time, attributing this data to a specific location. The associated "Dynamic Logging" file is viewed in the mapping/treatment plan software. A large amount of data is generated by dynamic logging and therefore must be saved onto an RDS Data Card Module. Job summary data (iii) is also appended to the dynamic logging file.

3. LOG SUMMARY ONLY (Field Data Logging)

For simple farm record keeping and traceability purposes, you can record a summary of each job or work session in the internal memory, and subsequently download directly to a PC, to a Data Module, or print to a printer. The amount of summary data for each job is small, and is saved in the internal memory. The instrument can store up to 75 individual job summaries.

Please refer to the 'GPS, Data Logging and Transfer' manual ref S/DC/500-10-384 for further information.

4 Alarm Codes

Code	Reason	Display	Checklist
-	<p>High forward speed</p> <p>Forward speed exceeds the maximum calculated and displayed on the RATE screen</p>		<ul style="list-style-type: none"> • Check the Target application rate is as required. • Check that the Calibration factor is realistic. • Adjust metering unit and recalibrate, which will increase kg/rev factor and therefore increase maximum achievable forward speed.
-	<p>Area cut-out</p> <p>Flashes up for 1 second every 3 seconds when system is 'out of work'</p>		<ul style="list-style-type: none"> • Check the drill is still lifted. • Operating logic not set correctly. • Check the wiring between sensor and connection box is correct. • Check the wiring between connection box and CAN module is correct.
L.1	<p>Low fan speed</p> <p>Fan speed is below the low alarm value programmed</p>		<ul style="list-style-type: none"> • Check the fan is running. • Check the fan sensor and target is functioning and correct. • Check the PPR value is programmed correctly.
L.2	<p>High fan speed</p> <p>Fan speed above the high alarm value programmed</p>		<ul style="list-style-type: none"> • Check the fan sensor and target is functioning and correct. • Check the PPR value is programmed correctly.
L.3.SS	<p>Seed level is low</p> <p>(Seed-only or Seed and Fert. drill - 1 metering unit per product)</p>		<ul style="list-style-type: none"> • Seed level is low. • Check the level sensor is functioning correctly. • Check the wiring between sensor and connection box is correct. • Check the wiring between connection box and CAN module is correct.
L.3.FS	<p>Fert. level is low</p> <p>(Seed and Fert. drill - 1 metering unit per product)</p>		<ul style="list-style-type: none"> • Fert. level is low. • Check the level sensor is functioning correctly. • Check the wiring between sensor and connection box is correct. • Check the wiring between connection box and CAN module is correct.

Code	Reason	Display	Checklist
L.3.SL	<p>Seed level left is low <i>(Seed-only drill with 2 metering units, independent left & right level sensors)</i></p>		<ul style="list-style-type: none"> • Seed level in left chute is low. • Check the level sensor is functioning correctly. • Check the wiring between sensor and connection box is correct. • Check the wiring between connection box and CAN module is correct.
L.3.SR	<p>Seed level right is low <i>(Seed-only drill with 2 metering units, independent left & right level sensors)</i></p>		<ul style="list-style-type: none"> • Seed level in right chute is low. • Check the level sensor is functioning correctly. • Check the wiring between sensor and connection box is correct. • Check the wiring between connection box and CAN module is correct.
L.3.SD	<p>Both seed levels are low <i>(Seed-only drill with 2 metering units, independent left & right level sensors)</i></p>		<ul style="list-style-type: none"> • Seed levels are low. • Check the level sensors are functioning correctly. • Check the wiring between sensors and connection box is correct. • Check the wiring between connection box and CAN module is correct.
L.3.FD	<p>Fert. level is low <i>(Seed and Fert. drill- 2 metering units per product)</i></p>		<ul style="list-style-type: none"> • Fert. levels are low. • Check the level sensors are functioning correctly. • Check the wiring between sensors and connection box is correct. • Check the wiring between connection box and CAN module is correct.
L.4.L	<p>Half Width Enabled – Left Side <i>(Seed-only drill - 2 metering units per product)</i></p>		<ul style="list-style-type: none"> • The left motor is disabled due to pressing the on-screen motor inhibit button. • Re-press the button to re-enable the motor, or ignore to continue with half width drilling.
L.4.R	<p>Half Width Enabled – Right Side <i>(Seed-only drill - 2 metering units per product)</i></p>		<ul style="list-style-type: none"> • The right motor is disabled due to pressing the on-screen motor inhibit button. • Re-press the button to re-enable the motor, or ignore to continue with half width drilling.

Code	Reason	Display	Checklist
L.5.S	Single Motor Metering Off		<ul style="list-style-type: none"> The motor is disabled due to pressing the on-screen motor inhibit button. Re-press the button to re-enable the motor, or ignore to continue with the motor inhibited.
L.5.D	Dual Motor Metering Off		<ul style="list-style-type: none"> Both motors are disabled due to pressing the on-screen motor inhibit buttons. Re-press the button to re-enable the motors, or ignore to continue with the motors inhibited.
L.6	Max Forward Speed		<ul style="list-style-type: none"> Based upon the calibration factor, this is the maximum speed that can be achieved. If this is too low, then open the metering unit slide further and re-calibrate.
L.7.SU	Seed Upper Level is Low (Pre-Level)		<ul style="list-style-type: none"> Seed upper level is low. Check the level sensor is functioning correctly. Check the wiring between sensor and connection box is correct. Check the wiring between connection box and CAN module is correct.
M.1.S	Seed motor speed high Error between actual motor speed and target motor speed is greater than 10%		<ul style="list-style-type: none"> Target motor speed too low. Erratic forward speed signal. Erratic loading on motor via metering unit.
M.2.S	Seed motor speed low. Error between actual motor speed and target motor speed is greater than 10%		<ul style="list-style-type: none"> Target motor speed too high. Erratic forward speed signal. Erratic loading on motor via metering unit.

Code	Reason	Display	Checklist
M.3.S	Seed metering unit is not going around.		<ul style="list-style-type: none"> • Check the seed metering unit rotates when the motor rotates. • Check the Shaft sensor and target is functioning and correct. • Check the PPR value is programmed correctly. • Check the wiring between sensor and connection box is correct. • Check the wiring between connection box and CAN module is correct.
M.3.L	Left Seed metering unit is not going around. <i>(Seed- only drill with 2 motors each driving 1 metering unit)</i>		<ul style="list-style-type: none"> • Check the left, seed metering unit rotates when the motor rotates. • Check the Shaft sensor and target is functioning and correct. • Check the PPR value is programmed correctly. • Check the wiring between sensor and connection box is correct. • Check the wiring between connection box and CAN module is correct.
M.3.R	Right Seed metering unit is not going around. <i>(Seed-only drill with 2 motors each driving 1 metering unit)</i>		<ul style="list-style-type: none"> • Check the right, seed metering unit rotates when the motor rotates. • Check the Shaft sensor and target is functioning and correct. • Check the PPR value is programmed correctly. • Check the wiring between sensor and connection box is correct. • Check the wiring between connection box and CAN module is correct.
M.3.LF	Fert. metering unit is not going around. <i>(Seed and Fert. drill with 2 motors each driving 2 metering unit)</i>		<ul style="list-style-type: none"> • Check the Fert. metering unit rotates when the motor rotates. • Check the Shaft sensor and target is functioning and correct. • Check the PPR value is programmed correctly. • Check the wiring between sensor and connection box is correct. • Check the wiring between connection box and CAN module is correct.
M.3.LFH	Left Fert. metering unit is not going around. <i>(Seed and Fert. drill with 2 motors each driving 2 metering unit)</i>		<ul style="list-style-type: none"> • Check the left, Fert. metering unit rotates when the motor rotates. • Check the Shaft sensor and target is functioning and correct. • Check the PPR value is programmed correctly. • Check the wiring between sensor and connection box is correct. • Check the wiring between connection box and CAN module is correct.

Code	Reason	Display	Checklist
M.3.SLH	Left Seed metering unit is not going around. <i>(Drill with 1 motor driving 2 metering units)</i>		<ul style="list-style-type: none"> • Check the left, seed metering unit rotates when the motor rotates. • Is the drill being operated at 1/2 width? • Check the Shaft sensor and target is functioning and correct. • Check the PPR value is programmed correctly. • Check the wiring between sensor and connection box is correct. • Check the wiring between connection box and CAN module is correct.
M.3.SRH	Right seed metering unit is not going around <i>(Drill with 1 motor driving 2 metering units)</i>		<ul style="list-style-type: none"> • Check the right, seed metering unit rotates when the motor rotates. • Is the drill being operated at 1/2 width? • Check the Shaft sensor and target is functioning and correct. • Check the PPR value is programmed correctly. • Check the wiring between sensor and connection box is correct. • Check the wiring between connection box and CAN module is correct.
M.4.S	Motor speed signal from seed motor not being received Motor being operated and pulses received from shaft confirmation sensors but no motor speed signal		<ul style="list-style-type: none"> • Check for signs of mechanical damage to encoder or cabling on motor. • Check the 3-way connector between the motor and harness is correct. • Check the wiring between the 3-way connector and the module connector is correct.
H.1.L	Left motor control module is 'offline'		<ul style="list-style-type: none"> • Check the wiring between the 6-way connector and the module connector on MCM harness. • If alarm H.1.T and H.1.R are also shown, then check between the 50-way D-connector on back of the head unit, and both 6-way and 4-way connectors of the instrument harness.
H.1.R	Right motor control module is 'offline'		<ul style="list-style-type: none"> • Check the wiring between the 6-way connector and the module connector on MCM harness. • If alarm H.1.T and H.1.L are also shown, then check between the 50-way D-connector on back of the head unit, and both 6-way and 4-way connectors of the instrument harness.

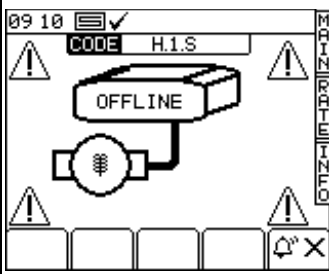
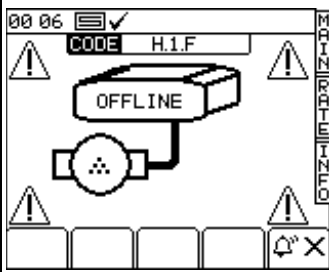
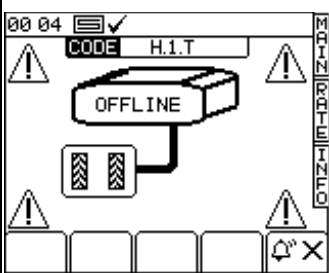
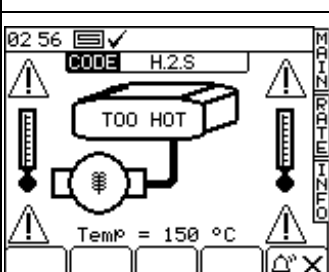
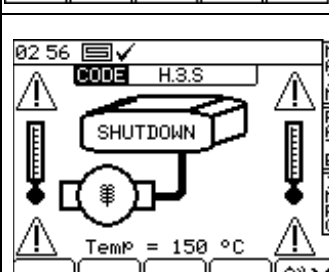
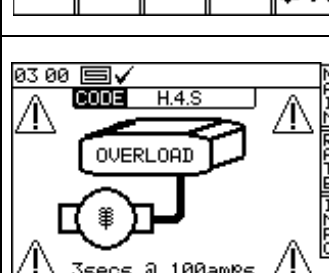
Code	Reason	Display	Checklist
H.1.S	Seed Motor Control Module is 'offline'		<ul style="list-style-type: none"> • Check the wiring between the 6-way connector and the module connector on MCM harness. • If alarm H.1.T is also shown, then check between the 50-way D-connector on back of the head unit, and both 6-way and 4-way connectors of the instrument harness.
H.1.F	Fert. motor control module is 'offline'		<ul style="list-style-type: none"> • Check the wiring between the 6-way connector and the module connector on MCM harness. • If alarm H.1.T and H.1.S are also shown, then check between the 50-way D-connector on back of the head unit, and both 6-way and 4-way connectors of the instrument harness.
H.1.T	Tramline module is 'offline'		<ul style="list-style-type: none"> • Check the module has got power from main battery, power cable. • Check the wiring between the 4-way connector and the module connector on HBM harness. • If alarm H.1.S is also shown, then check between the 50-way D-connector on the back of the head unit, and both the 6-way and 4-way connectors of instrument harness.
H.2.S	Seed motor module temperature too hot Module temperature has exceeded the value programmed		<ul style="list-style-type: none"> • The Motor speed is very low. • Excessive load applied to motor for a prolonged time, causing the module high temperature. • Check metering unit for damage / obstruction. • Re-calibrate to get motor turning faster.
H.3.S	Seed motor module temperature shutdown Module temperature has exceeded the value programmed		<ul style="list-style-type: none"> • The Motor speed is very low. • Excessive load applied to motor which for a prolonged time, causing the module high temperature and shutdown. • Check metering unit for damage / obstruction. • Re-calibrate to get motor turning faster.
H.4.S	Seed motor module overload shutdown Motor current requirement exceeded, so the module is shutdown and motor operation is inhibited		<ul style="list-style-type: none"> • The Motor is stalled. • Excessive drag on the metering unit, requiring motor high current.

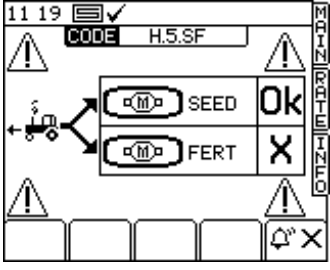
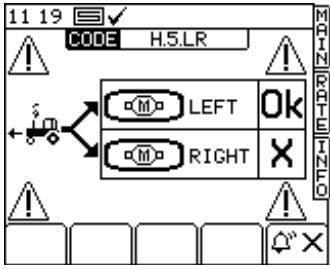
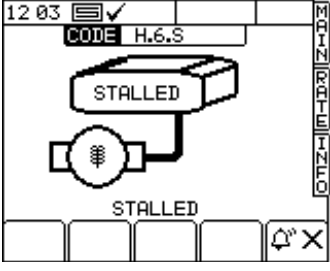
Code	Reason	Display	Checklist
<p>H.5.SF</p>	<p>Forward Speed Failure (Seed & Fert)</p>		<ul style="list-style-type: none"> • Check wiring of the forward speed input in alarmed connection box. • Check for continuity between pin 2A on MCM 1 (white wire) and pin 2A on MCM 2.
<p>H.5.LR</p>	<p>Forward Speed Failure (Left & Right)</p>		<ul style="list-style-type: none"> • Check wiring of the forward speed input in alarmed connection box. • Check for continuity between pin 2A on MCM 1 (white wire) and pin 2A on MCM 2.
<p>H.6.S</p>	<p>Motor has Stalled</p>		<ul style="list-style-type: none"> • Check for blockages in the metering unit. • Disconnect the motor from the metering unit, and ensure both units rotate separately. • Check the motor and gearbox. • Lift drill to clear alarm.

Document History

Issue 1:	7/8/07	Original issue
Issue 2:	6/5/11	Updated to match latest revision of software. Included alarm codes
Issue 2.1	10/5/11	Updated schematic (figure 1)
Issue 2.2	27.1.12	Minor corrections to section 4