

# PM500 OPERATOR'S MANUAL

---



# PM500 OPERATOR'S MANUAL



<b>1</b>	<b>INTRODUCTION</b>	<b>4</b>
<b>2</b>	<b>PM500 SPECIFICATIONS</b>	<b>6</b>
<b>3</b>	<b>MAJOR FEATURES</b>	<b>7</b>
<b>4</b>	<b>QUICK START GUIDE</b>	<b>8</b>
	<b>PLANTER CONFIGURATION</b>	<b>8</b>
	TO SELECT A PRE-PROGRAMMED PLANTER CONFIGURATION	8
	FOR MANUAL PLANTER DATA ENTRY	8
	<b>GROUND SPEED CONFIGURATION</b>	<b>8</b>
	TO PERFORM A NEW CALIBRATION	9
	FOR MANUAL GROUND SPEED CONSTANT ENTRY	9
	<b>TRAMLINING CONFIGURATION</b>	<b>9</b>
	TO SELECT A PRE-PROGRAMMED TRAMLINING CONFIGURATION	9
	FOR MANUAL TRAMLINING DATA ENTRY	10
	<b>HELP CARD</b>	<b>10</b>
<b>5</b>	<b>KEYS</b>	<b>12</b>
	ON / OFF	12
	ALARM CANCEL	12
	ENTER	13
	ESCAPE (VALVE ON/OFF)	13
	UP & DOWN ARROWS	13
	RIGHT & LEFT ARROWS	13
	BOUT ADJUST	14
	ROW SHUT OFF SELECT	14
	ROW SHUT OFFS	14
<b>6</b>	<b>INSTALLATION AND SET UP</b>	<b>15</b>
	MOUNTING STANDARD BRACKET	15
	OPTIONAL 3D ADJUSTABLE BRACKET MOUNTING	15
	INSTALLING CONSOLE HARNESSSES	16
	INSTALLING RSO MODULE & RSO TRACTOR POWER HARNESS	17
	INSTALLING IMPLEMENT HARNESS AND SENSORS	18
	PM500 SET-UP	19
	MENU	19
	PLANTER & GROUND SPEED (MANDATORY DATA ENTRY)	19
	ROW SET-UP (AUTO ASSIGNED) AND RSO OUTPUTS (MANDATORY)	20
	TRAMLINING (MANDATORY FOR TRAMLINING)	21
	ACCESSORIES (OPTIONAL)	; <b>ERROR! MARCADOR NO DEFINIDO.</b>
	POPULATION (OPTIONAL)	22
	USER INTERFACE (OPTIONAL)	23
	AUXILLIARY MODES (SPEED, AREA, DISTANCE & SEED COUNTING)	25
<b>7</b>	<b>MONITORING</b>	<b>26</b>
	MAIN SCREEN	26
	PARAMETER OUTPUTS AND SCROLLING (UPPER SCREEN)	26
	ROW INDICATORS (LOWER SCREEN)	26
<b>8</b>	<b>TRAMLINING</b>	<b>28</b>

# PM500 OPERATOR'S MANUAL



<b>9</b>	<b>OPEN-LOOP FLOW CONTROL AND MONITORING ...</b>	<b>¡ERROR! MARCADOR NO DEFINIDO.</b>
	INSTALLING ARAG VALVE.....	¡ERROR! MARCADOR NO DEFINIDO.
	OPEN-LOOP FLOW CONTROL CONFIGURATION.....	¡ERROR! MARCADOR NO DEFINIDO.
	OPEN-LOOP FLOW CONTROL OPERATION .....	¡ERROR! MARCADOR NO DEFINIDO.
	OPEN-LOOP FLOW CONTROL MAIN SCREEN .....	¡ERROR! MARCADOR NO DEFINIDO.
<b>10</b>	<b>MONITORING FUNCTIONS .....</b>	<b>30</b>
	AVERAGE POPULATION.....	¡ERROR! MARCADOR NO DEFINIDO.
	MINIMUM / AVERAGE / MAXIMUM POPULATION .....	¡ERROR! MARCADOR NO DEFINIDO.
	POPULATION ROW SCAN .....	¡ERROR! MARCADOR NO DEFINIDO.
	AVERAGE SPACING.....	¡ERROR! MARCADOR NO DEFINIDO.
	MINIMUM / AVERAGE / MAXIMUM SPACING.....	¡ERROR! MARCADOR NO DEFINIDO.
	SPACING ROW SCAN.....	¡ERROR! MARCADOR NO DEFINIDO.
	AVERAGE SEEDS PER DISTANCE .....	¡ERROR! MARCADOR NO DEFINIDO.
	MINIMUM / AVERAGE / MAXIMUM SEEDS PER DISTANCE.....	¡ERROR! MARCADOR NO DEFINIDO.
	SEEDS PER DISTANCE ROW SCAN .....	¡ERROR! MARCADOR NO DEFINIDO.
	FIELD AREA 1 .....	¡ERROR! MARCADOR NO DEFINIDO.
	FIELD AREA 2 .....	¡ERROR! MARCADOR NO DEFINIDO.
	TOTAL AREA .....	¡ERROR! MARCADOR NO DEFINIDO.
	SPEED.....	¡ERROR! MARCADOR NO DEFINIDO.
	AREA PER HOUR .....	¡ERROR! MARCADOR NO DEFINIDO.
	FAN .....	¡ERROR! MARCADOR NO DEFINIDO.
	SHAFT .....	¡ERROR! MARCADOR NO DEFINIDO.
	FLOW .....	¡ERROR! MARCADOR NO DEFINIDO.
	TRAMLINER .....	<b>32</b>
<b>11</b>	<b>ALARMS .....</b>	<b>33</b>
<b>12</b>	<b>AUXILLIARY MODES .....</b>	<b>35</b>
	SPEED, AREA, DISTANCE MODE .....	<b>35</b>
	SEED COUNTING .....	<b>35</b>
<b>13</b>	<b>TROUBLESHOOTING .....</b>	<b>36</b>
<b>14</b>	<b>ERROR &amp; ALARM CODES .....</b>	<b>¡ERROR! MARCADOR NO DEFINIDO.</b>
<b>15</b>	<b>PLANTER AND TRAMLINING CONFIGURATIONS.....</b>	<b>39</b>
<b>16</b>	<b>CONNECTOR PIN-OUTS .....</b>	<b>40</b>
	CONSOLE.....	<b>40</b>
	BATTERY .....	40
	GROUND SPEED.....	40
	RSO CONTROL (CAN).....	40
	IMPLEMENT .....	40
	RSO HARNESS .....	<b>41</b>
	POWER (HITCH) .....	41
	RSO CONTROL (HITCH).....	41
	RSO MODULE (GREY CONNECTOR BODY) .....	41
	RSO MODULE (BLACK CONNECTOR BODY) .....	42
	RSO CLUTCHES (ROWS 1,2,5,6) .....	42

# PM500 OPERATOR'S MANUAL

---



RSO CLUTCHES (Rows 3,4,7,8,9,10,11,12) .....	42
<b>RSO POWER HARNESS (BATTERY TO HITCH) .....</b>	<b>42</b>
BATTERY .....	42
HITCH .....	43
<b>VALVE ADAPTER HARNESS .....</b>	<b>¡ERROR! MARCADOR NO DEFINIDO.</b>
RSO OUTPUTS (9, 10, 11, 12) .....	<b>¡ERROR! MARCADOR NO DEFINIDO.</b>
MAIN SHUT-OFF VALVE (RSO 9 HI AND RSO 10 LO) .....	<b>¡ERROR! MARCADOR NO DEFINIDO.</b>
FLOW ADJUSTMENT VALVE (RSO 11 HI AND RSO 12 LO) .....	<b>¡ERROR! MARCADOR NO DEFINIDO.</b>
<b>17 PARTS AND WARRANTY INFORMATION .....</b>	<b>44</b>
<b>APPENDIX A. USING THE RSO MODULE WITH HIGH CURRENT DEVICES .....</b>	<b>45</b>

# PM500 OPERATOR'S MANUAL



## 1 INTRODUCTION

The DICKEY-john PM500 Planter Monitor/Controller offers features to monitor up to 12 seed or fertilizer rows, 2 hopper levels, and 3 frequency inputs (shaft, fan, flow). The unit also provides a CAN bus interface for interface to a Row Shut Off (RSO) module. With the RSO module, the PM500 can control 12-row shut-off solenoids.

The PM500 is compatible with DICKEY-john seed, flow, hopper level, application rate (shaft), and flow sensors. The unit stores all configuration data in nonvolatile memory, retaining information even when disconnected from power. Figure 1 shows the PM500 console and RSO module.

The PM500 is designed to meet the custom needs of individual users. The display is configurable to output a comprehensive set of planter output parameters, but the user selects which parameters and the number of parameters they want to monitor. If they prefer to monitor population and field area alone – those two parameters will be displayed in a large, highly readable font. If the user desires more parameters, simply select them in the easy to navigate set-up. In any case, the user is in control of the data they need to view. Similarly, row information can be viewed in a bar graph, gauge, or symbol form. The information can be selected to be large (for ease of viewing), or smaller (for viewing the entire planter). Auto-scrolling and arrow key override is used so the user stays in control of the real-time information they need to see.

Figure 1. PM500 and RSO module

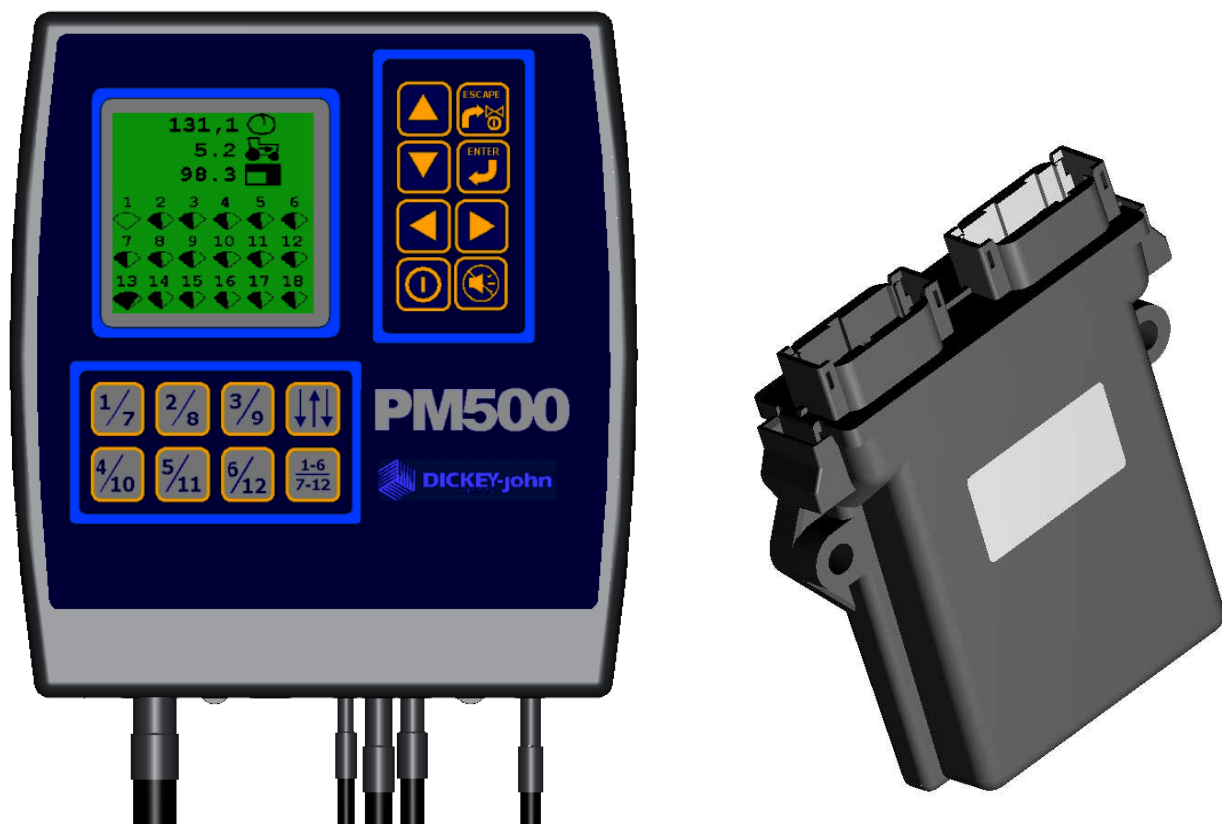

# PM500 OPERATOR'S MANUAL



Figure 2. PM500 user-definable display examples

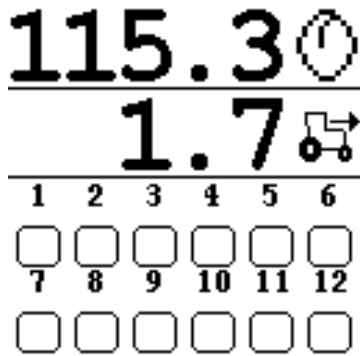

Average population and speed output with row symbols

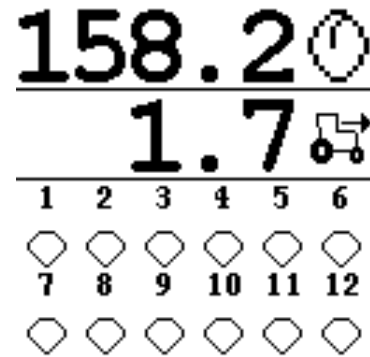

Average population and speed output with row gauges

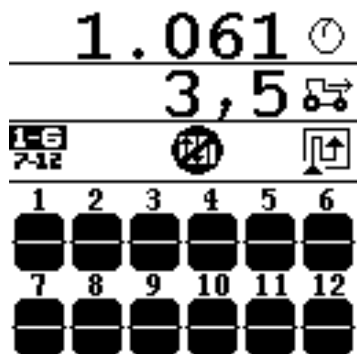

Average population, speed, and tramlining (disabled) with row bar graphs

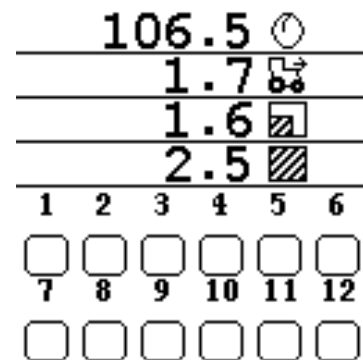

Average population, speed, field area, and total area output with row symbols

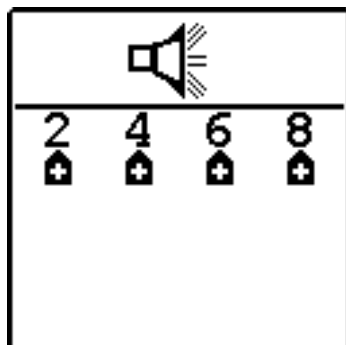

Rows 2, 4, 6, 8 (above limit) alarm screen

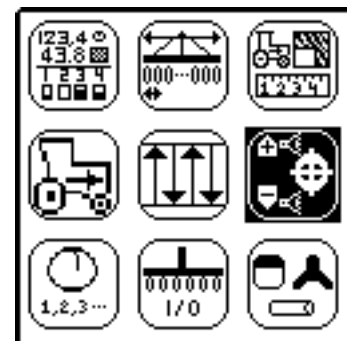

Main Menu

# PM500 OPERATOR'S MANUAL

---



## 2 SPECIFICATIONS

- **PM500 power:** 10-16 VDC, 0.5 A maximum (6.0 A maximum with 12 seed sensors)
- **RSO module power:** 10-16 VDC, 0.5 A maximum (module only)
- **RSO maximum drive current:** 20A with thermal protection  
(12 row system - 1.5A max sustained per row @ 25°C)
- **Operating temperature range:** -20°C to 70°C
- **Storage temperature range:** -40°C to 85°C
- **Size:** PM500 18.4 by 18.4 by 18.0 cm (7.3 by 7.3 by 7.1 inches)  
RSO module 13.3 by 12.1 by 3.3 cm (5.3 by 4.8 by 1.3 inches)
- **Weight:** 6.8 kg (15 lbs.) for 6-row PM500 system
- **Harnessing:** The PM500 includes integrated harnesses to supply the unit's power (fused), ground speed input, CAN bus communications (to hitch) and sensor inputs (to hitch). The connectors are compatible with existing DICKEY-john harnessing. DICKEY-john can supply the custom harnessing required for sensor inputs.

The RSO module is supplied without integrated harnesses. DICKEY-john can supply the custom harnessing required for battery, CAN bus (to console at hitch), and row shut off device connections.

- **Sensors:** Compatible with existing DICKEY-john sensors
- **Mounting:** Rear mounted horizontal or vertical mount bracket. Optional detachable, three-axis adjustable mounting bracket
- **Contrast adjustment:** Automatic temperature compensation for contrast
- **Back light adjustment:** Three settings for full sun, daytime, or night time use
- **CE certified**
- **Dust and moisture resistant**

# PM500 OPERATOR'S MANUAL

---



## **3 MAJOR FEATURES**

Major features of the PM500 include the following:

- Planter monitoring and row control in a single system
- Monitoring of 12 rows, ground speed, 2 hopper levels, 3 frequencies (fan, shaft, flow), lift switch, and markers
- Direct or pre-programmed control of 12 row shut off devices
- Choice of bout advancement means (planter markers, lift switch, all rows fail, or manual)
- Easy and flexible configuration
- User definable interface of 2, 3, or 4 viewable performance outputs (all can be selected)
  - Average Population
  - Population Row Scan
  - Population Minimum Row, Maximum Row, and Planter Average
  - Average Seed Spacing
  - Seed Spacing Row Scan
  - Seed Spacing Minimum Row, Maximum Row, and Planter Average
  - Average Seeds per Distance
  - Seeds per Distance Row Scan
  - Seeds per Distance Minimum Row, Maximum Row, and Planter Average
  - Field Area 1 & 2
  - Total Area
  - Ground Speed
  - Seeds per Distance (m/ft)
  - Fan Frequency
  - Shaft Frequency
  - Flow Rate (always on line 1 when in open-loop control mode)
- User definable real-time row information
  - Bar Graph
  - Wiper Gauge
  - Symbols
  - Symbols flashing proportional to seeding rate (as defined by limits)
- User definable font sizes for ease of reading
- Graphical or text based output labels
- Back lit graphical display for night time use
- 3 level back light intensity adjustment
- Large, concise error messages on display with audible alarm
- Large, tactile keys
- English or metric units
- Compatible with DICKEY-john sensors
- Plug-in replacement for other DICKEY-john monitors
- Supports RS-232 based data logging (Average Population, Row Populations, Number of Sensors, Distance Traveled, Implement Width)
- Vertical/horizontal mounting bracket (Optional 3D adjustment bracket)



# PM500 OPERATOR'S MANUAL



## 4 QUICK START GUIDE

The PM500 includes a built-in library of popular planter configurations (see Section 15, Planter and Tramlining Configurations). A second library supports tramlining configurations.

Three inputs are required for monitor operation. These include planter parameters (number of rows and row spacing), a ground speed constant, and tramlining parameters (number of bouts, advance signal, and bout definitions). Selecting a pre-programmed planter configuration provides easy set-up of planter row width, number of rows, implement width, and row types. Selecting a pre-programmed tramlining configuration provides easy set-up of number of bouts, bout configurations, and RSO assignments.

### PLANTER CONFIGURATION



To program the PLANTER configuration, depress ENTER and the MENU will be displayed.

Select the PLANTER icon, and depress enter.

The PLANTER configuration screen will be shown.

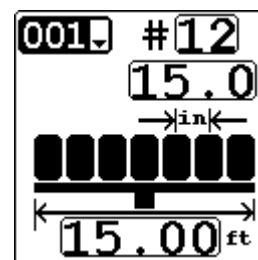

### TO SELECT A PRE-PROGRAMMED PLANTER CONFIGURATION

The configuration number will be highlighted when the PLANTER set-up screen is selected. Depress ENTER to modify the configuration number. To enter a unique or user defined planter configuration, the first character must be changed to an asterisk (For example, change 001 to \*01). Use the ARROW keys to select digits, increment, and decrement values. Depress ENTER to accept the new number. Depress ESCAPE to return to the MENU and ESCAPE again to return to the MAIN SCREEN.

### FOR MANUAL PLANTER DATA ENTRY

To enter a unique or user defined planter configuration, the first character must be changed to an asterisk (For example, change 001 to \*01). Use the ARROW keys to highlight the number of rows. Depress ENTER to modify the number of rows. Use the ARROW keys to select digits, increment, and decrement values. Depress ENTER to accept the new number. Enter the row spacing in the same manner. Once the new values are entered, depress ESCAPE to return to the MENU and ESCAPE again to return to the MAIN SCREEN.

### GROUND SPEED CONFIGURATION

If a Hall Effect sensor is used, the GROUND SPEED the factory default 0185 ground speed constant may be sufficient. If a ground speed RADAR is used, a calibration is required.

# PM500 OPERATOR'S MANUAL

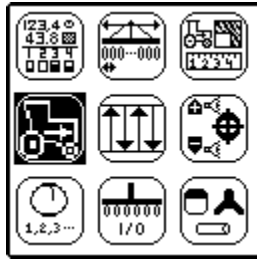

To select the GROUND SPEED screen, depress ENTER and the MENU will be displayed.

Select the GROUND SPEED icon, and depress enter.

The GROUND SPEED configuration screen will be shown.

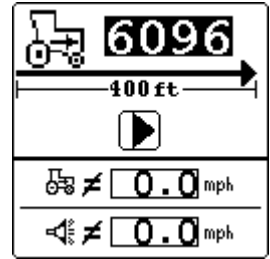

## TO PERFORM A NEW CALIBRATION

Use the ARROW KEYS to highlight the START button. Depress ENTER to start the 122m calibration. After the calibration is started, the button will change to a STOP button. Drive 122m and stop the vehicle. Depress ENTER to STOP the calibration. The new calibration factor will be shown in the window. Depress ESCAPE to return to the MENU and ESCAPE again to return to the MAIN SCREEN.

## FOR MANUAL GROUND SPEED CONSTANT ENTRY

Use the ARROW keys to highlight the manual ground speed value. Depress ENTER to modify the constant. Use the ARROW keys to select digits, increment, and decrement values. Depress ENTER to accept the new number. Once the new values are entered, depress ESCAPE to return to the MENU and ESCAPE again to return to the MAIN SCREEN. Any non-zero value

**NOTE:** Correct speed calibration testing should be performed by verifying the proper speed output from the speed/area/distance screen.

## TRAMLINING CONFIGURATION

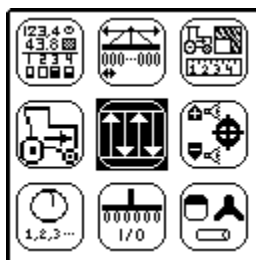

To program the TRAMLINING configuration, depress ENTER and the MENU will be displayed.

Select the TRAMLINING icon, and depress enter.

The TRAMLINING configuration screen will be shown.

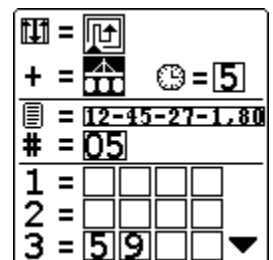

## TO SELECT A PRE-PROGRAMMED TRAMLINING CONFIGURATION

The direction of travel function will be highlighted when entering the screen. Depress ENTER to modify the direction of travel. Depress the RIGHT/LEFT arrow keys to define the direction of travel. The icon will change with the key depression. Depress ENTER to accept the new direction of travel (this icon also changes on the MAIN OPERATRE screen).

Use the ARROW keys to select the tramline advancement means (Markers, Lift switch, All rows failed, or manual) Depress ENTER to modify the advancement means. Use the ARROW keys to increment or decrement values. Depress ENTER to accept the new mechanism.

# PM500 OPERATOR'S MANUAL

---



The configuration number will be highlighted when the TRAMLINING set-up screen is selected. Depress ENTER to modify the configuration number. Use the UP/DOWN ARROW keys to select a preprogrammed configuration. Depress ENTER to accept the configuration. The format is:

RR – SS – WW - TT  
Number of rows – Row spacing – Sprayer width – Tire spacing

Depress ESCAPE to return to the MENU and ESCAPE again to return to the MAIN SCREEN.

***NOTE: Proper tramlining operation should be verified by manually advancing through the bouts while in the main operate screen. Screen information should be checked against the planter shut-off mechanisms to assure proper wiring and programming has been performed.***

## FOR MANUAL TRAMLINING DATA ENTRY

The configuration number will be highlighted when the TRAMLINING set-up screen is selected. Depress ENTER to modify the configuration number. Use the UP/DOWN ARROW keys to select a custom configuration (C1-C5). Depress ENTER to modify the custom configuration.

Use the ARROW keys to select the number of bouts. Use the ARROW keys to increment or decrement values. Depress ENTER to accept the new value.

Use the ARROW keys to select the tramline advancement means (Markers, Lift switch, All rows failed, or manual). Depress ENTER to modify the advancement means. Use the UP/DOWN ARROW keys to increment or decrement values. Depress ENTER to accept the new mechanism.

Use the DOWN ARROW key to select the first bout. Depress ENTER to modify the first bout (if required). Use the ARROW keys to increment or decrement rows to be disabled in bout one. Depress ENTER to accept the new values. Modify the remaining bout numbers as required.

Once all of the new values are entered, depress ESCAPE to return to the MENU and ESCAPE again to return to the MAIN SCREEN.

While many additional features can be programmed into the console, no more are required for the system to function as a planter monitor with tramlining and manual RSO capability.

## **HELP CARD**

The help card can be removed for a compact reference for definitions, set-up screens, and general operating information.

# PM500 OPERATOR'S MANUAL



Figure 3. HELP CARD

PM 500 Help card Carte d'aide Hilfe Karte Tarjeta de la ayuda Scheda di aiuto			
<b>Population</b> Population Población Bevölkerung Popolazione	<b>Seed Spacing</b> Espacement de Graine Espaciamiento de la Semilla Samen-Abstand Gioco Del Seme	<b>Row Scan</b> Balayage de Rangée Exploración de la Fila Reihe Scan Esplorazione di Fila	
<b>Hi/Lo Row</b> Range de Hi/Lo Fila de Hi/Lo Hi/Lo Reihe Fila de Hi/Lo	<b>Field Area</b> Région de Champ Área del Campo Feld-Bereich Zona del Campo	<b>Total Area</b> Surface Totale Área Total Ganzes Gebiet Area Totale	<b>Distance</b> Distance Distancia Abstand Distanza
<b>Ground Speed</b> Vitesse Velocidad Geschwindigkeit Velocità	<b>Flow</b> Écoulement Flujo Fluß Flusso	<b>Shaft</b> Axe Árbol Welle Asse	<b>Fan</b> Ventilateur Ventilador Gebläse Ventilatore
<b>Security</b> Sécurité Seguridad Sicherheit Sicurezza	<b>Valve</b> Valve Válvula Ventil Valvola	<b>Markers</b> Marqueurs Marcadores Markierungen Indicatori	<b>All Rows Failed</b> Toutes les rangées échouent Todas las filas fallaron Alle Reihen fallen aus Tutte sono venute a mancare
<b>Lift Switch</b> Soulevez le commutateur Levante el interruptor Heben Sie Schalter an Alzi l'interruttore	<b>Reset</b> Remise Zurückstellen Reajuste Risistemazione	<b>Hopper</b> Distributeur Tolva Zufuhrbehälter Tramoggia	

 001 40.0cm 4.80m #1=12	 1536 122 m 5.5 KPH 10 KPH	 123.4 43.8 1 3 4 5.6
<b>Planter</b> Planteur Plantador Pflanze Piantatrice	<b>Ground speed</b> Vitesse Velocidad Geschwindigkeit Velocità	<b>User interface</b> Interface utilisateur Interfaz utilizador Benutzerschnittstelle Interfaccia di utente
 1/0 1 2 3 4 5 6 7 8 9 10	 8 2 4 3 5	 120% 1536.0 80% 80 100%
<b>Row and Shut-off</b> Rangée et Interruption Fila y cierre Reihe und Absperrvorrichtung Fila ed Interruttore	<b>Tramlining</b> Tramlining Tramlining Tramlining Tramlining	<b>Population target</b> Cible de population Blanco de la población Bevölkerung Ziel Obiettivo della popolazione
 1000 2000 1000 2000	 5.4 98.9 1289.2 153.4	 1-12-0 1 112946 7 117106 2 127910 8 142105 3 112919 9 111044 4 102943 10 112135 5 111044 11 117106 6 112135 12 127910
<b>Accessories</b> Accessoires Accesorios Zusatzgeräte Accessori	<b>Speed/Area/Distance</b> Vitesse/Secteur/Distance Velocidad/Área/Distancia Geschwindigkeit/Bereich Velocità/Zona/Distanza	<b>Seed Counting</b> Compte de graine Cuenta de la semilla Samen-Zählen Conteggio del seme



## 5 KEYS

Figure 4. PM500 keys



### ON / OFF



The unit activates when the ON/OFF is pressed. Upon power up, the PM500 performs internal self-tests, illuminates the display, sounds the alarm, and determines which sensors are connected to the system. Pressing the key for one second when power is on will power down the system, independent of the screen being displayed.

### ALARM CANCEL



During normal operation, pressing this switch acknowledges the alarm conditions that are displayed on the screen. All active alarms are reset after an All Rows Failure condition or a power down-up sequence occurs. If the error condition remains after reset, the switch must be pressed again to cancel the alarm. When no alarms are active, volume can be modified by pressing and holding the ALARM CANCEL key.

# PM500 OPERATOR'S MANUAL

---



## ENTER



Depression of ENTER moves the user from the main operate screen to the main menu or to the selected screen.

Once an item is selected, depression of the ENTER key will change modes from navigation to data modification. After changing parameter values, ENTER accepts the modified data.

## ESCAPE



In the MAIN OPERATE SCREEN, depressing ESCAPE for three seconds will clear a field accumulator *if it is located on the top line*.

When navigating through screens, the ESCAPE key moves the user back one selection. Multiple ESCAPE presses will return the user to the main operate screen. After changing parameter values, ESCAPE accepts the modified data.

## UP & DOWN ARROWS



In the MAIN SCREEN the arrows are used to manually select the parameters being viewed in the top of the display. They are inactive if all parameters are already displayed (number of parameters are equal to or less than number of lines).

## RIGHT & LEFT ARROWS

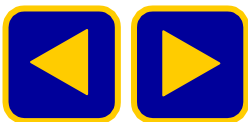

The RIGHT & LEFT ARROWS provide unique functions depending upon the screen being displayed.

In the MAIN SCREEN, the arrows are used to manually select the rows being viewed in the bottom of the display. They are inactive if all rows are already displayed. When BOUT ADJUST (see below) is active, the arrows are used to select bout number. When in the MAIN MENU or in a particular screen, the arrows are used to navigate between options.

# PM500 OPERATOR'S MANUAL

---



## BOUT ADJUST

Pressing this switch allows the user to pause tramlining and change the bout number. After being pressed, the bout number will be highlighted. This is the only mode when the bout can be advanced using the RIGHT/LEFT ARROWS. A second depression of the TRAMLINING key returns the unit to normal operation.

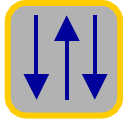

## ROW SHUT OFF SELECT



Pressing this switch toggles the definition of the ROW SHUT OFF keys between rows 1-6 and rows 7-12. The display will indicate the current state of the keys' definitions by showing either 1-6 or 7-12.

## ROW SHUT OFFS

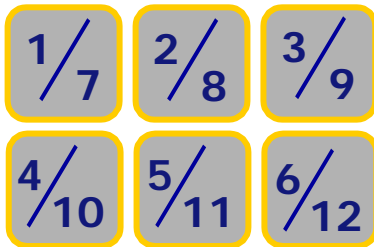

Pressing these switches toggle the state of the corresponding row. If row 1 is planting and rows 1-6 are active (see ROW SHUT OFF SELECT), pressing the 1/7 key will turn row 1 off.



## 6 INSTALLATION AND SET UP

Before shipping, the PM500 is tested and inspected to insure the unit is fully operational and meets all measurement specifications. After unpacking, inspect for damage that may have occurred during transit. Save all packing materials until inspection is complete. If damage is found, immediately file a claim with the carrier. Also notify your DICKEY-john Sales Representative.

### MOUNTING STANDARD BRACKET

Install the mounting bracket to the location of your choice using your hardware. Install the bracket to the console by sliding it into the mating grooves until the snap engages.

**WARNING:** *The console must not obstruct the view or interfere with the operation of the tractor.*

**CAUTION:** *To prevent damage, assure the snap fully engages when installing bracket to console.*

Figure 5. Mounting bracket installation

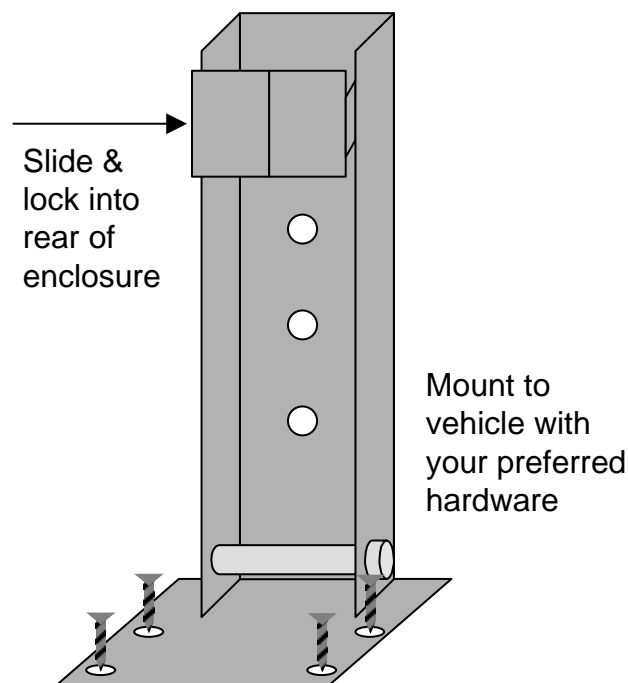

### OPTIONAL 3D ADJUSTABLE BRACKET MOUNTING

Detach the brackets two-halves from one another by loosening the wing bolt. Install the upper half (rectangular section) into the console by sliding it into the mating grooves until the snap engages. Install the bottom-half mounting bracket to the location of your choice using your hardware.

**WARNING:** *The console must not obstruct the view or interfere with the operation of the tractor.*



# PM500 OPERATOR'S MANUAL



**CAUTION:** To prevent damage, assure the snap fully engages when installing bracket to console.

Figure 6. Mounting bracket installation

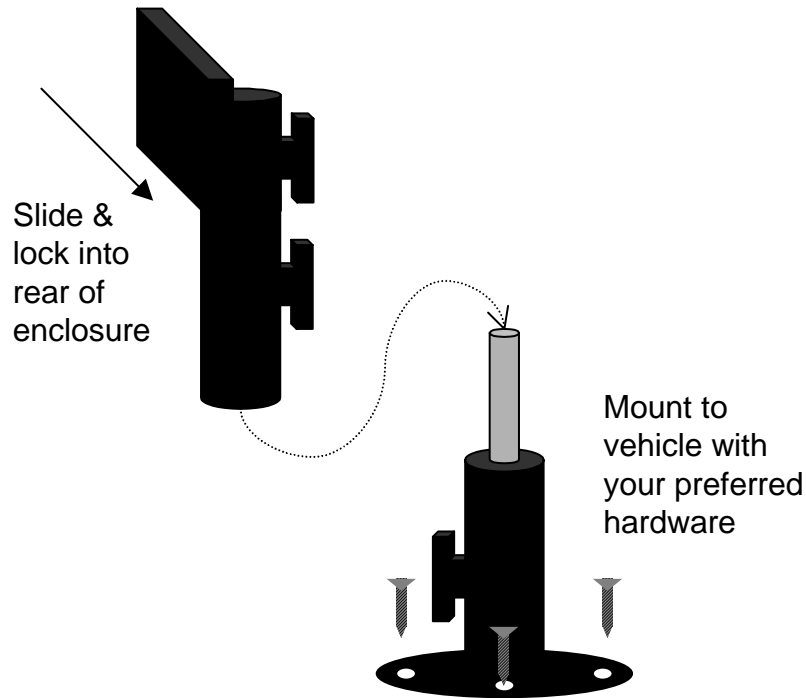

## INSTALLING CONSOLE HARNESES

Several harnesses exit the bottom of the PM500. These include power, ground speed sensor, communication (CAN and RS-232), and sensor inputs (12 rows, lift switch, 2 markers, 2 hopper levels, fan, shaft, and flow).

1. Route the power harness to a +12V source near the battery if possible.
2. Route the ground speed sensor to the connection to the RADAR, Hall Effect, or GPS ground speed sensor.
3. Route the implement harness to the location of your choice, typically the hitch.
4. If needed, route the CAN bus harness along the path of the implement harness.

**CAUTION:** The harnesses must not obstruct movement of the operator or of the moving parts of the tractor or implement. Take care when routing harnesses to retain them at proper locations with slack if needed for movement.

**CAUTION:** Poor +12V connections can cause intermittent console operation. Be sure to connect battery to a clean, well-conditioned source (direct battery connection is best).

# PM500 OPERATOR'S MANUAL



Figure 7. Console harnesses

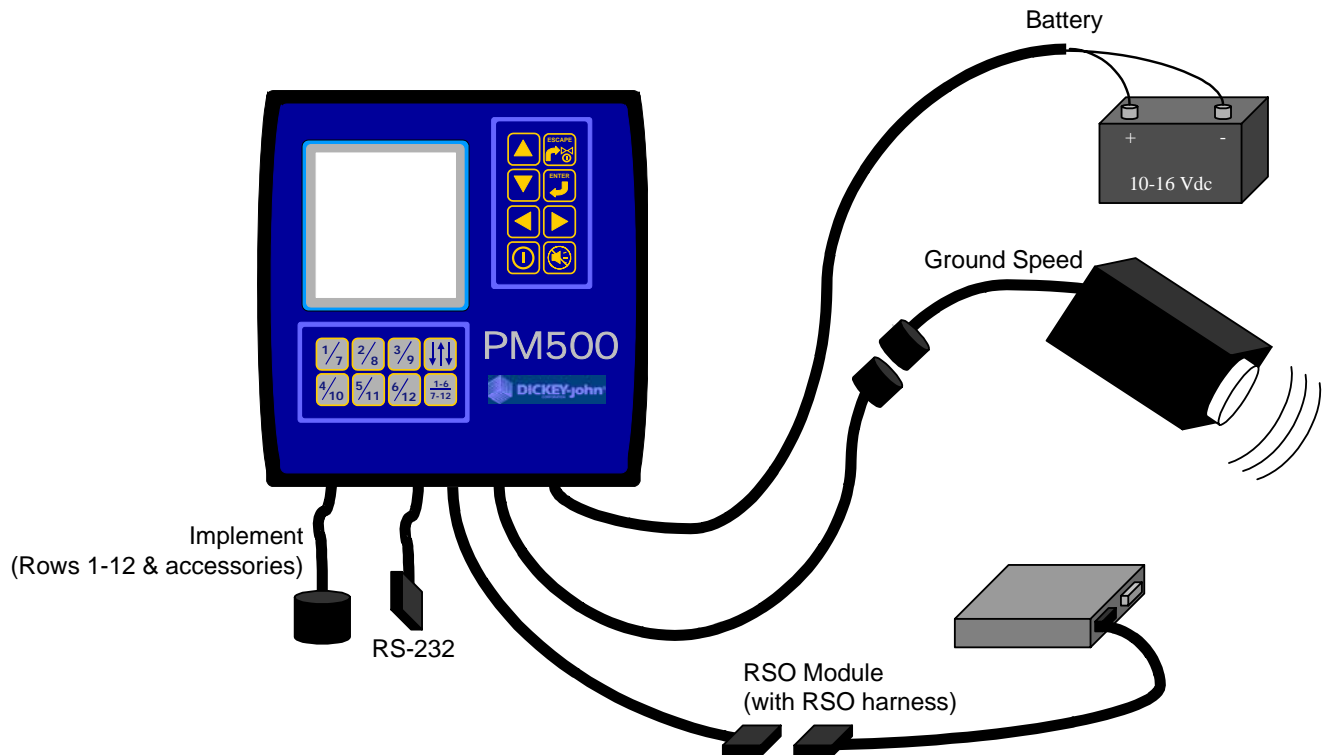

## INSTALLING RSO MODULE & RSO TRACTOR POWER HARNESS

Mount the RSO module to the location of your choice using your hardware. The RSO module is typically installed in the middle of the implement near the row units.

The RSO power harness typically provides a large amount of current to the RSO system. It is important to route the RSO tractor power harness directly from the battery to the hitch.

***WARNING: Due to the high amperage requirements of RSO equipment, the RSO harness must be routed to the battery (through the hitch connection). The hitch connection must be kept in clean, non-corroded working condition (low resistance).***

The RSO module includes an indicator. The indicator can be used to assure the RSO module is properly powered and communicating with the PM500 console.

# PM500 OPERATOR'S MANUAL



RSO Module indicator status	Condition	Possible cause of error
Normal blink (1 per second)	Proper communications established	None, module is communicating with PM 500 console.
Fast blink (2 per second)	Powered with no communications	CAN bus lines broken or not connected. Check 6-position connector and RSO module connections.
On (no blink)	Powered with internal fault detected	Internal fault detected or RSO lines shorted. Check RSO connections and/or replace RSO module.
Off	Not powered	Check RSO module, harness, PM500 console, and battery connections.

Figure 8. RSO module, RSO harness, and implement harness

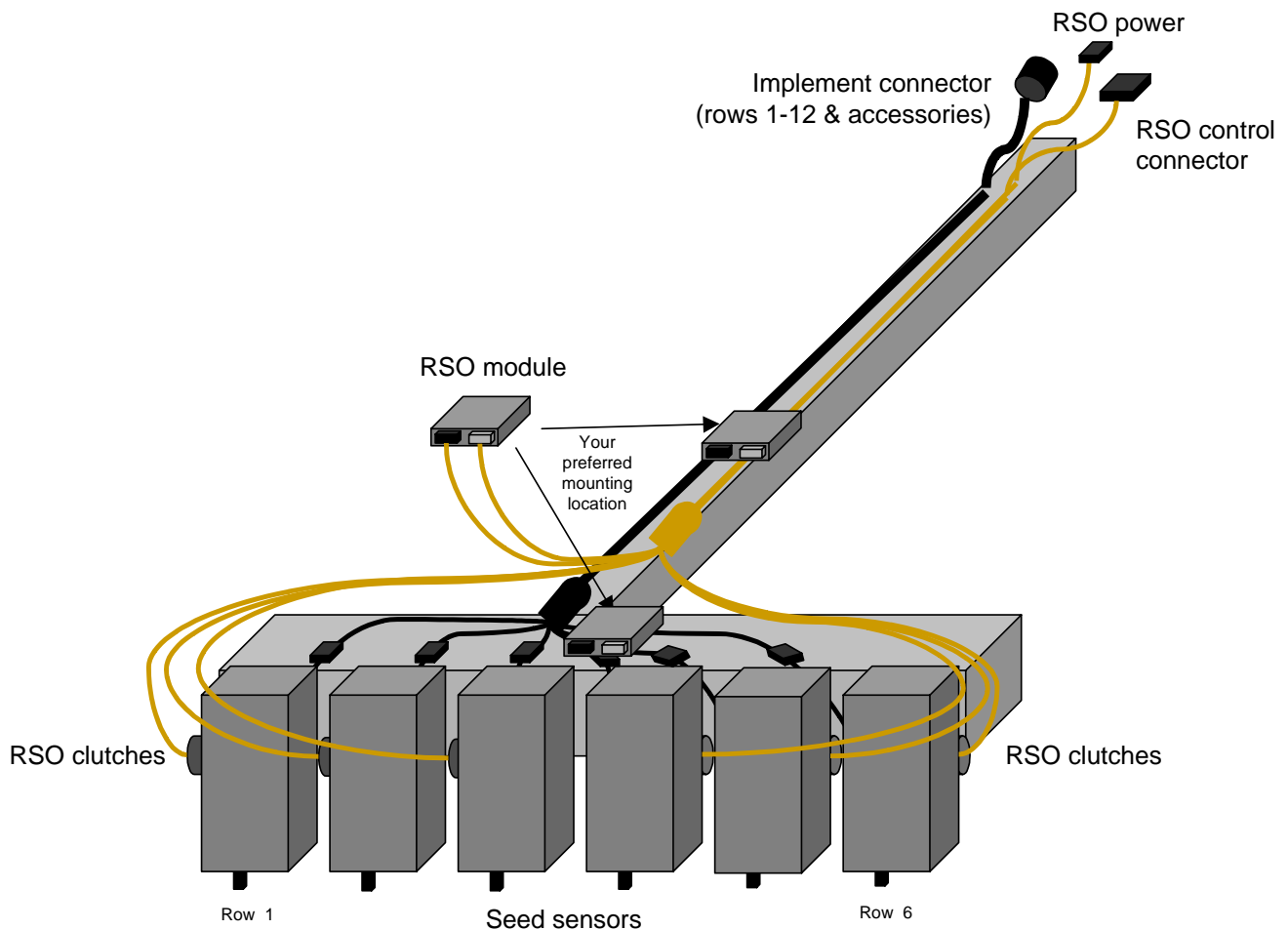

## INSTALLING IMPLEMENT HARNESS AND SENSORS

The implement harness provides the custom fit and functions required by your implement. Each harness branch is labeled for the location (row 1, row 2, etc) or sensor (lift switch) that it must be routed for connection. Some sensors may require special adapters for connection.

# PM500 OPERATOR'S MANUAL



1. Install sensors onto seed tubes using ty-wraps.
2. Route the implement harness to the appropriate locations, taking care to leave proper lengths near moving parts and attach as required by your implement using ty-wraps.
3. Assure the hitch connections will connect to the tractor connections with the proper amount of slack for implement movement.

**CAUTION:** *The harnesses must not obstruct movement parts of the tractor or implement. Take care when routing harnesses to retain them at proper locations with slack if needed for movement.*

## SET-UP

The PM500 is designed to be simple for basic monitoring while supporting an expanded set of features for the advanced user. In any case, you the user decide which features to configure.

### MENU

From the default operate screen, depress ENTER to display the menu. The menu screen includes 7 set-up screen selections and two specialized operation screens (seed count and speed/area/distance).

Figure 9. Menu

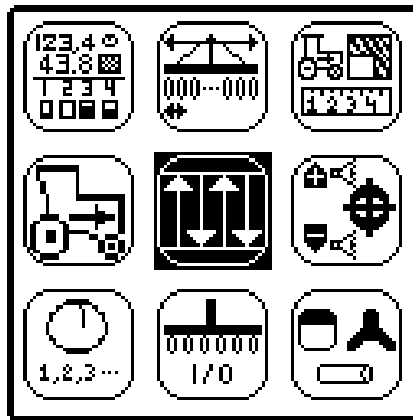

### PLANTER & GROUND SPEED (MANDATORY DATA ENTRY)

There are two set-up screens that require inputs for your system to function as a monitor, PLANTER and GROUND SPEED. If RSO functions are desired, the ROW I/O and RSO screen also require inputs.



The PLANTER screen must include the number of rows and the row spacing or implement width for the console to properly display population. The user can pre-program up to three different configurations. This supports users with split row planters (configuration 1 for normal and 2 for split row) and a separate seeder or drill (configuration 3).

# PM500 OPERATOR'S MANUAL



The GROUND SPEED screen must include a calibration factor for proper calculation and display of ground speed. Also included in the GROUND SPEED screen are a calibration aid, a manual ground speed value, and a maximum speed alarm. The calibration aid can be used to measure the calibration factor, which is the number of pulses in 122 m (400 ft). The manual ground speed (optional) can be used when a ground speed sensor is not installed or has failed in the field. The maximum speed alarm (optional) provides the user with an over speed alarm.

Figure 10. Planter and Ground Speed Set-up Screens

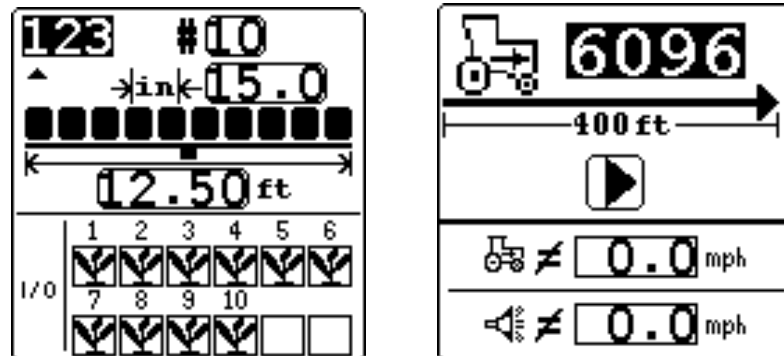

## ROW SET-UP (AUTO ASSIGNED) AND RSO OUTPUTS (MANDATORY)

The console will automatically assign the number of rows defined in the PLANTER screen as ON, and the RSO modules as directly mapped unless the user overrides these settings.

Rows can be configured to be ON, OFF (split row), FLOW, or DISABLED.

- When ON is selected (plant), the row is active and the console will detect sensors and seed flow.
- When OFF is selected (blank), the row is removed and remaining rows are re-numbered. This is used for split row systems where every other row or sets of internal rows are not planting. Their corresponding row number is ignored, allowing for true planting operations to be displayed on the monitor.
- When DISABLED is selected (circle with slash), the row input is ignored. The row number will be displayed. This is used when a row or sensor is malfunctioning and the operator wants to disable monitoring on that row.
- When FLOW is selected (funnel), the row will not be included for population calculations, but will be monitored for flow. The flow rows will be used to detect flow (fertilizer or seeds) and alarm if the flow falls below 2 pulses per second.

The RSO outputs will be directly assigned to the row numbers for most users. However, since some users may assign outputs to different row numbers, all RSO outputs must be assigned to their associated row numbers. The example below depicts a 10-row planter with direct assignment.

# PM500 OPERATOR'S MANUAL



Figure 11. Row Shut-Off (RSO) Screen

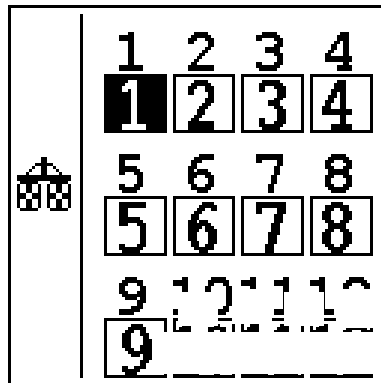

## TRAMLINING (MANDATORY FOR TRAMLINING)

The PM500 provides 18-bout (maximum) tramlining capability. The number of bouts must be programmed first. Next, the tramlining advancement mechanism must be selected. The mechanism can be the transition of right/left planter marker switches, a lift switch, an All Rows Failure, or a manual button depression. Lastly, the RSO assignments for each bout must be entered. A maximum of 4 rows can be entered in a given bout.

Figure 12. Tramlining screen

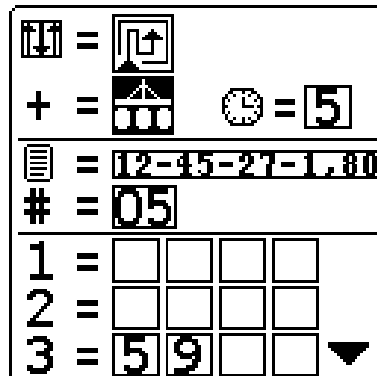

# PM500 OPERATOR'S MANUAL



## ACCESSORIES (OPTIONAL)

To add auxiliary sensors and their performance characteristics (calibration values, limits, etc) to the monitoring inputs, they must be activated by entering a calibration constant. If minimum or maximum alarms are desired, the limits can be added to the calibrated sensors. Fan, shaft, or flow sensors can be monitored with hi and/or low alarms or no alarm values.

Figure 13. Accessory screen

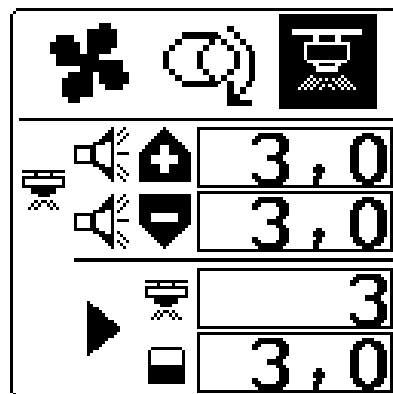

## POPULATION (OPTIONAL)

The population screen allows the user to define several population features. The user can define a target population. If no value is selected, the monitor will use the average population as a calculation for alarms and row indicators. Minimum and maximum limits can be assigned with either percentage or value based entries. If the % box is checked, the entry is percentage based, otherwise it is value based. A population adjustment factor is available to provide a means to display populations nearer the actual than the sensed seeding rates. This is useful when sensors do not detect doubles, triples, etc. Lastly, the population response rate is also selectable. This feature is used to provide population display stability for planters with few rows versus planters with many.

Figure 14. Population screen

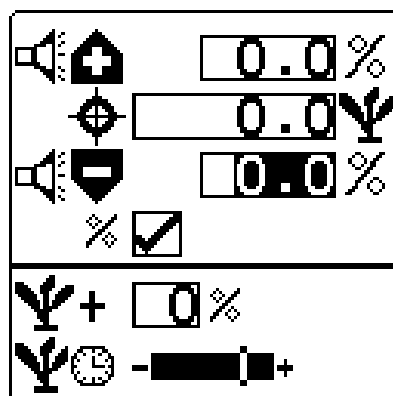

# PM500 OPERATOR'S MANUAL



## USER INTERFACE (OPTIONAL)

A primary consideration in the PM500 design is the ability to provide the flexibility in display information to fit the needs of individual operators. The user interface screen is used to customize the display to include only the information the operator desires. Factory default selections are set for typically desired parameters for basic monitoring. However, the broad range of PM500 input features requires the ability to allow the user to define the information available for viewing and the size of the information (small, medium, or large).

The top of the display includes the upper and lower screen set-up icons. Below these icons lie the Metric/English selection, alarm volume, and back light intensity. The graphic/display allows the user to view graphic symbols or text-based labels (I.E.  versus k/hr). The Metric/English allows the operator to select the units they prefer. The alarm volume and back light intensity have 3 levels of adjustment. The security feature allows the PM500's password protected security levels to be activated. This protects hired, untrained personnel from modifying key parameters in the field. Defaults are graphic, metrics, high volume, medium back light, and unlocked security.

The upper screen parameters can be modified by selecting the upper screen icon and depressing enter. Once the upper screen is entered, the upper half of the display depicts the screen modifications while the lower half is used for changing selected parameters or font sizes (see figure 15). The bar selection causes the font size to be large, medium, or small, respectively. Default value is 3 lines (medium).



The user can select which parameter they want displayed in numerical order from the following list. (Also refer to section 8, Monitoring Functions).

- Average Population
- Average Seed Spacing
- Average Seeds per Distance (m/ft)
- Population Row Scan
- Seed Spacing Row Scan
- Seed per Distance Row Scan
- Minimum, Maximum, Average Row Population
- Minimum, Maximum, Average Row Spacing
- Minimum, Maximum, Average Spacing per Distance
- Field Area 1
- Field Area 2
- Total Area 3
- Ground Speed
- Fan, Shaft, or Flow Frequency

Default values are 3 parameters that include 1 = average population, 2 = seed spacing row scan, 3 = field area 1.



# PM500 OPERATOR'S MANUAL



The lower screen parameters can be modified by selecting the lower screen icon and depressing enter. The row indicator type and size can be selected in the top selector.  Types include blinking box (blink rate proportional to seeding rate), solid box, bar graph, or wiper gauge. These can be displayed in a small, medium, or large size, which is the next selection item. The size determines the number of rows that can be displayed on the bottom half of the display. Default is non-blinking box, medium size.

Figure 15. User interface screens (primary, upper half, and lower half)



# PM500 OPERATOR'S MANUAL

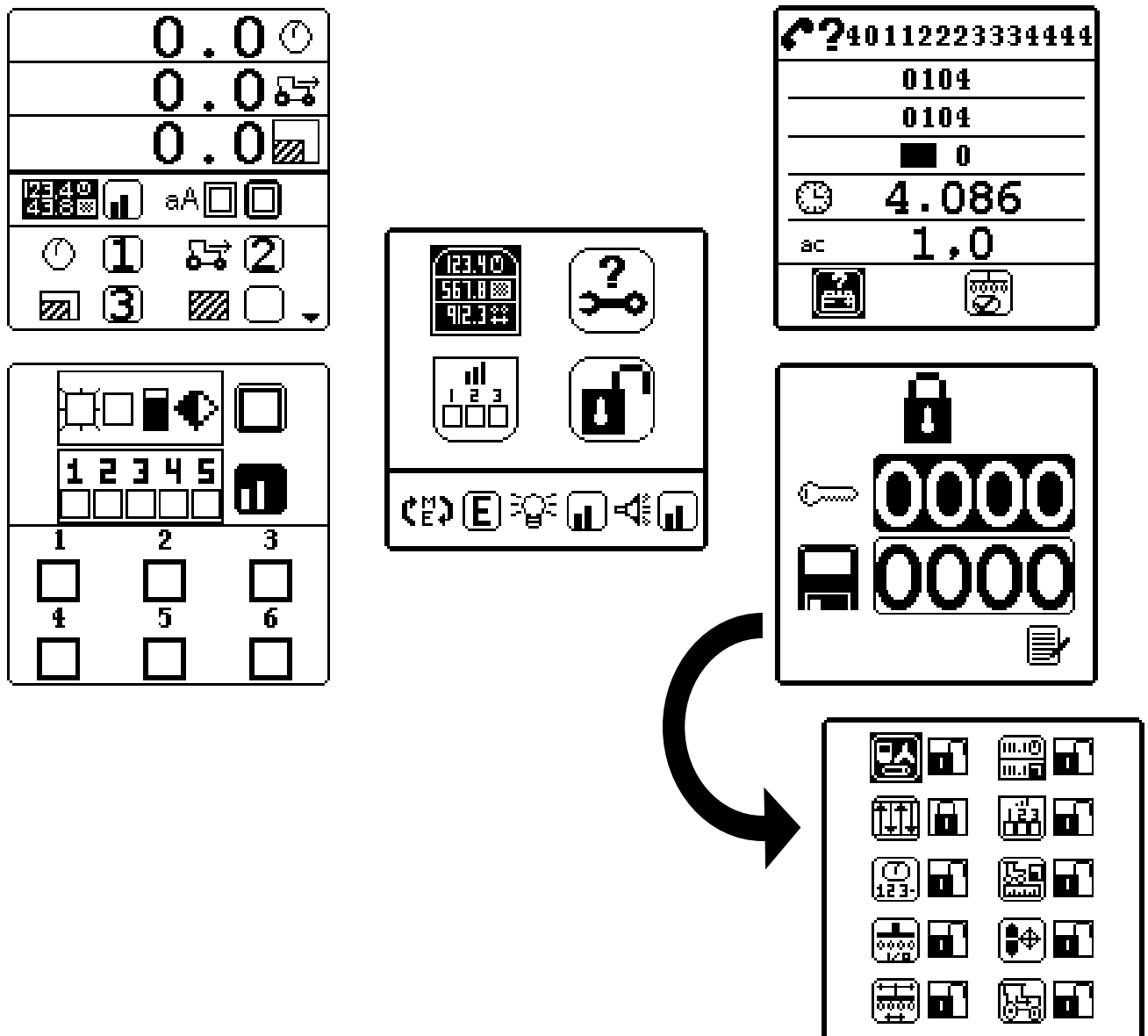

## AUXILLIARY MODES (SPEED, AREA, DISTANCE & SEED COUNTING)

The Speed, Area, Distance mode provides monitoring for non-planting operations like open loop spraying, area monitoring, or distance measurement.

The Seed Counting mode can be used for planter testing in the shop.

The Speed, Area, Distance mode includes resets for Field Area (hc1/ac1), Total Area (hc2/ac2), Distance, and all parameters reset.

The Seed Counting mode includes a reset for all rows.

**Caution: Alarms are disabled in these modes.**

Figure 16. Speed, area, & distance and Seed counting screens

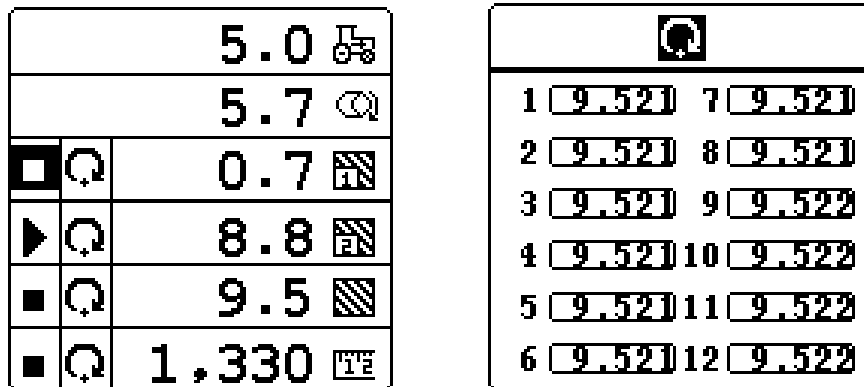

# PM500 OPERATOR'S MANUAL



## 7 MONITORING

### MAIN SCREEN

The PM500's main screen provides the monitoring and control functions. No matter where a user has navigated in the set-up, security, or auxiliary modes, they can repeatedly depress the ESCAPE key to return to the main screen.

The main screen is divided into two halves, upper and lower. The upper half provides user definable output parameters (population, area, speed, etc) while the lower half is dedicated to row information.

### PARAMETER OUTPUTS AND SCROLLING (UPPER SCREEN)

Through the User Interface settings, it is possible for more parameters to be selected than can be displayed on the screen. If more parameters are selected than are available, then the up/down arrow is used to scroll between the parameters. This function provides wrapping. As an example, if 5 parameters are selected:

- 1 = Average population
- 2 = Speed
- 3 = Field area
- 4 = Total area
- 5 = Shaft RPM

If the screen were configured to display 3 items, the main screen would display average population, speed and field area. When the down arrow is depressed, the screen would display items 2, 3, and 4. A second depression of the down arrow would display items 3, 4, and 5.

```
      33.3 Ψ
-----
      16.8 ⚙
-----
      16.9 📊
-----
  1  2  3  4  5  6
  □ □ □ □ □ □
  7  8  9 10 11 12
  □ □ □ □ □ □
```

If the screen were configured to display 4 items, Average population, speed, field area, and total area would be shown.

```
      33.1 Ψ
-----
      16.8 ⚙
-----
      17.5 📊
-----
      17.5 📊
-----
  1  2  3  4  5  6
  □ □ □ □ □ □
  7  8  9 10 11 12
  □ □ □ □ □ □
```

# PM500 OPERATOR'S MANUAL

---



## ROW INDICATORS (LOWER SCREEN)

The number of rows displayed in the lower half are user definable. Since more rows can be ON than are viewable, the monitor automatically scrolls through the rows every 5 seconds when this occurs (bar graph with large font on 12-row machine). The operator can use the right/left arrows to manually select which rows they desire. The automatic scrolling will restart 10 seconds after a manual selection.

*Note (Tramlining): When the bout selection is activated (see section 8), the right/left arrows allow for manual selection of the bout number instead of lower half display scrolling.*

Figure 17. Main screen (12-row default screen with tramlining off)

---

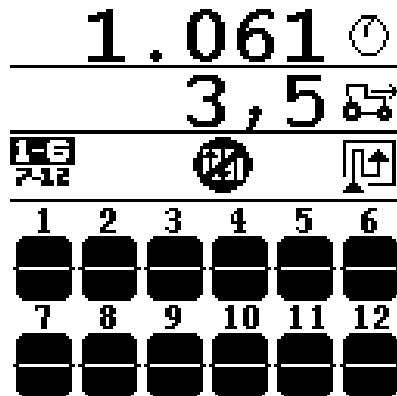

# PM500 OPERATOR'S MANUAL



## 8 TRAMLINING

Programming the ROW TYPE & SHUT-OFF and TRAMLINING SCREENS (see section 5) configures the monitor for tramlining. To view tramlining parameters, the tramlining function must be activated in the User Interface Set-up screen (see Section 6, User Interface). When tramlining is selected, the function icon indicates the manual shut offs assignment (1-6 or 7-12), the active and total number of programmed bouts, and the icon indicates the direction of travel (left-to-right or right-to-left). Direction of travel must be programmed in the TRAMLINING set-up screen.

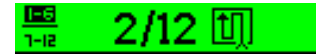

Tramline advancement can be performed manually or automatically. Automated advancement means must be selected in the TRAMLINING set-up screen and include:

- Markers (The first bout starts by the proper marker lowering, per the direction of travel)
- Lift Switch
- All Rows Failed

When the bout number is highlighted, manual advancement is active and automated advancement is paused.



The direction of travel is used to determine the RSO sequencing. The PM500 defines a left-to-right field planting operation for tramlining definitions in the TRAMLINING SET-UP screen. If a right-to-left direction of travel is desired, the PM500 automatically reverses the



row number assignments to accomplish proper RSO sequencing. The direction of travel is indicated through the TRAMLINING icon.

The 8 keys located on the lower portion of the PM500 are dedicated to RSO and tramlining functions.

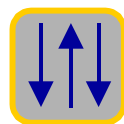
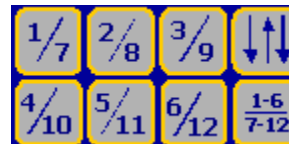

The BOUT ADJUST key causes the right/left arrow keys to be assigned to bout selection functions. While tramlining adjustment is active, the right/left keys increment or decrement the bout number. Setting the bout number to zero disables tramlining. A second depression of the tramlining key returns the unit to normal operation.



The 1-6 / 7-12 key toggles the manual shut off key assignments between the respective rows.

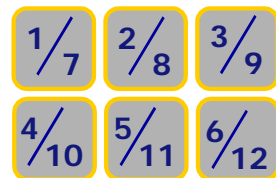

Assuming the correct key assignment is selected (1-6 or 7-12), direct and immediate toggling of RSO can be accomplished by depressing the appropriate RSO key. The lower half of the display will indicate which rows are shut off (regardless of tramlining or manual shut-off) by displaying an X in the respective row position. This function can override tramlining by turning rows ON that were shut off through programming.

# PM500 OPERATOR'S MANUAL



*Note: When rows are turned off from the outside of the planter towards the inside of the planter, the rows are removed from area calculations.*



A warning symbol will be displayed if planting is detected on a row that is supposed to be shut off, either manually or through tramlining.

Tramlining definitions take top priority in regards to RSO functions. In other words, tramlining will always toggle rows per the bout definitions. Manual RSO is a secondary function. Rows that are not defined to toggle state in the last and new bouts will remain in the state of default or manual control. For example, suppose rows 1 & 2 are manually turned off in bout one. If bout two is configured to have rows 1 & 4 OFF and bout three is configured to have rows 5 & 8 OFF and 1& 4 ON, row 1 will move to an ON state in bout three, while row 2 will remain OFF. The difference lies in the definition of row 1 toggling from OFF to ON between bouts two and three in the tramlining sequence.

	Programmed	Manual	Result
Bout 1	□□□□■□□■	■□□□□□□□	■□□□■□□■
Bout 2	■□□■□□□□	□□□□□□□□	■□□■□□□□
Bout 3	□□□□■□□■	□□■□□□□□	□■□□■□□■
Bout 4	■□□■□□□□	□□□□□□□□	■□□■□□□□
Bout 5	□□□□■□□■	□□□■□□□□	□■□□■□□■
Bout 6	■□□■□□□□	□□□□□□□□	■□□■□□□□



## 9 MONITORING FUNCTIONS

The operator can choose to simultaneously view 2, 3, or 4 monitoring or control functions and may select several more that require a touch of an arrow key to view. Factory default parameters are population, spacing, and tramlining.

### AVERAGE POPULATION



The AVERAGE population function displays the average of the planter's rows in seeds per hectare (s/ha) or per acre (s/ac) that are configured for population. The population response rate and population adjustment can be modified in the target set-up screen. This function can be labeled with a symbol or text, depending upon the text/graphic setting.

### MINIMUM/ AVERAGE/ MAXIMUM POPULATION



The MINIMUM / AVERAGE / MAXIMUM population function alternates the display of the minimum row, planter average, and maximum row every 2 seconds. When a minimum or maximum row is being displayed, the corresponding symbol is shown with the row number.

### POPULATION ROW SCAN



The ROW SCAN function displays the population of each of the planter's rows. The console increments the displayed row every 2 seconds. After the last row is displayed, the console returns to the first active row for another scan sequence.

### AVERAGE SPACING



The AVERAGE spacing function displays the average of the planter's rows in seed spacing (cm or in) that are configured for population. This function can be labeled with a symbol or text, depending upon the text/graphic setting.

### MINIMUM/ AVERAGE/ MAXIMUM SPACING



The MINIMUM / AVERAGE / MAXIMUM spacing function alternates the display of the minimum row, planter average, and maximum row every 2 seconds. When a minimum or maximum row is being displayed, the corresponding symbol is shown with the row number.

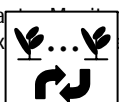

# PM500 OPERATOR'S MANUAL

---



## SPACING ROW SCAN

The ROW SCAN function displays the spacing of each of the planter's rows. The console increments the displayed row every 2 seconds. After the last row is displayed, the console returns to the first active row for another scan sequence.

## AVERAGE SEEDS PER DISTANCE

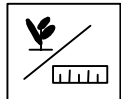

The AVERAGE seeds per distance function displays the average of the planter's rows in seeds per distance (m or ft) that are configured for population. This function can be labeled with a symbol or text, depending upon the text/graphic setting.

## MINIMUM/ AVERAGE/ MAXIMUM SEEDS PER DISTANCE



The MINIMUM / AVERAGE / MAXIMUM seeds per distance function alternates the display of the minimum row, planter average, and maximum row every 2 seconds. When a minimum or maximum row is being displayed, the corresponding symbol is shown with the row number.

## SEEDS PER DISTANCE ROW SCAN



The ROW SCAN seeds per distance function displays the seeds per distance of each of the planter's rows. The console increments the displayed row every 2 seconds. After the last row is displayed, the console returns to the first active row for another scan sequence.

## FIELD AREA 1

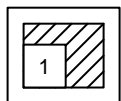

The FIELD AREA (HA1/AC1) function displays the field area in hectares or acres, depending upon the English/Metric setting. This function can be labeled with a symbol or text, depending upon the text/graphic setting.

## FIELD AREA 2

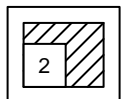

The FIELD AREA (HA2/AC2) function displays the field area in hectares or acres, depending upon the English/Metric setting. This function can be labeled with a symbol or text, depending upon the text/graphic setting.



# PM500 OPERATOR'S MANUAL

---



## TOTAL AREA

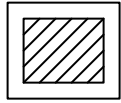

The TOTAL AREA (HA3/AC3) function displays the total area in hectares or acres, depending upon the English/Metric setting. This function can be labeled with a symbol or text, depending upon the text/graphic setting.

## SPEED

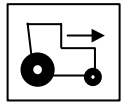

The SPEED function displays the vehicle speed in Miles per Hour (MPH) or Kilometers per Hour (KPH), depending upon the English/Metric setting. This function can be labeled with a symbol or text, depending upon the text/graphic setting.

## AREA PER HOUR

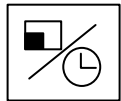

The AREA PER HOUR function displays the current rate of area per hour (HC/HR or AC/HR).

## FAN



The FAN function displays the fan's speed in Revolutions Per Minute (RPM).

## SHAFT

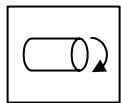

The SHAFT function displays the shaft's speed in Revolutions Per Minute (RPM).

## FLOW

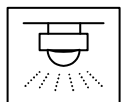

The FLOW function displays the flow rate speed in gallons per acre (g/ac) or liters per hectare (l/ha).

## TRAMLIN

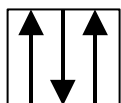

The TRAMLIN function displays the status of the active RSO switches (1-6 or 7-12), the bout number, the total number of bouts, tramline paused (highlighted bout is paused), tramline disabled, and the direction of travel.

# PM500 OPERATOR'S MANUAL



## 10 ALARMS

Primary operating alarms are displayed using the entire screen and are accompanied by an audible alarm. These alarms include:

Row blockage (two seeds per second threshold) - solid ON alarm

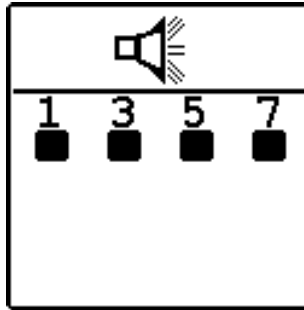

All rows failure – 8 chirps

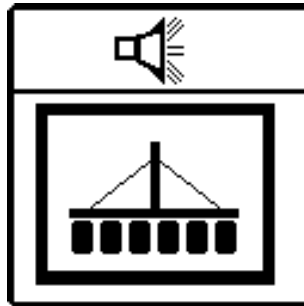

Hi or low limit exceeded (optional limits for population) – solid ON alarm

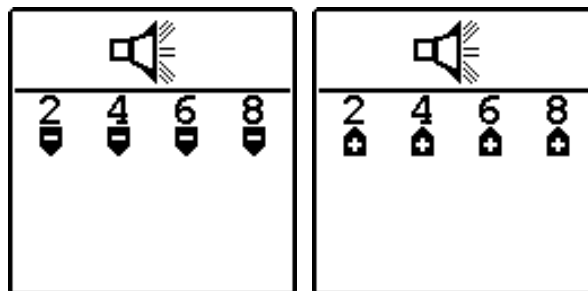

# PM500 OPERATOR'S MANUAL



Hi or low limit exceeded (optional limits for accessories) – solid ON alarm

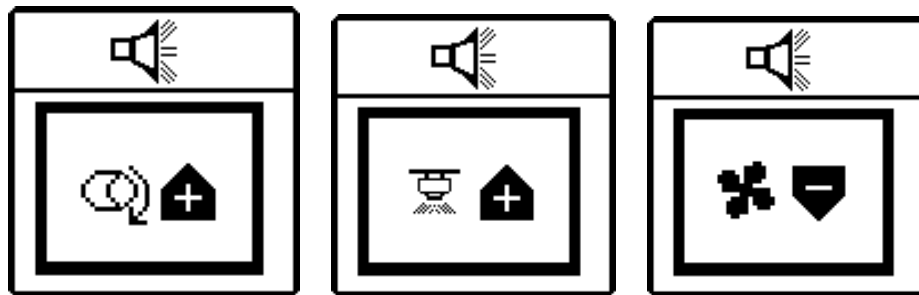

Failed ground speed sensor (planting detected without ground speed)

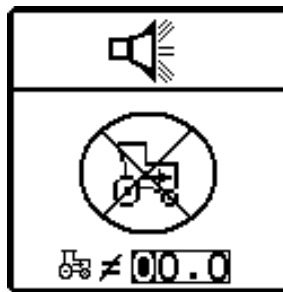

Self test failure (battery voltage out of limits)

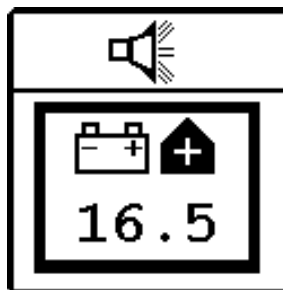

Maximum speed exceeded (optional)

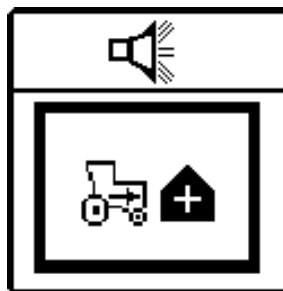

An audible 2-chirp alarm is also output during navigation or data entry to indicate an illegal or non-functional key press.

# PM500 OPERATOR'S MANUAL



## 11 AUXILLIARY MODES

The PM500 provides modes for alternative monitor use and row unit testing.

### SPEED, AREA, DISTANCE MODE

The speed, area, and distance modes can be used for cultivating.

Figure 18. Speed, area, distance screen

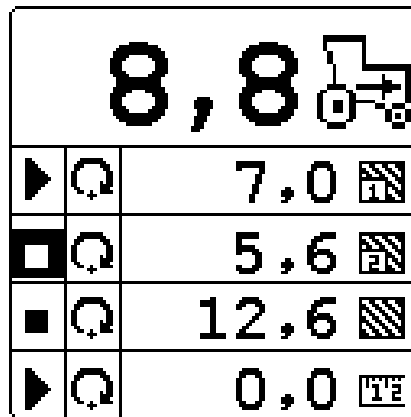

### SEED COUNTING

The seed counting mode can be used to determine row unit performance when operating the planter in a stationary manner.

Figure 19. Seed counting

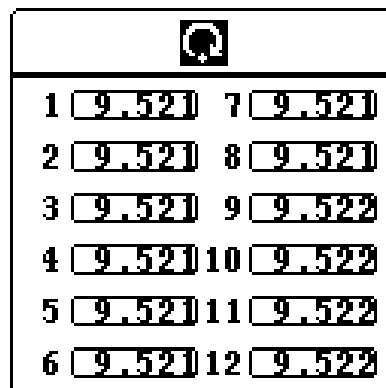

# PM500 OPERATOR'S MANUAL



## 12 TROUBLESHOOTING

Symptom	Probable Cause	Action Required
Monitor will not power on	Blown console fuse	Check fuse (located near battery connection). If needed, replace with 7.5A fuse maximum. If fuse blows again, check all harnesses for pinches or breaks that may cause power short to ground.
	Poor battery connection	Assure connections are clean and tight. Inspect harness for damage.
	Low battery voltage	Console voltage must be at least 10V. If low, recharge or replace battery.
	Defective console	Console is damaged. Contact your dealer, DICKEY-john Europe (011-33-141-192189), or DICKEY-john USA (1-800-637-3302).
RSO outputs do not function	Tramlining is not configured	If manual row shut off functions but tramlining does not function, check the advancement means (manual, all rows fail, lift switch, or markers). If means is correct, assure tramlining is not paused (bout is not highlighted) by depressing the tramline key.
	Tramlining is off	Advance from off to bout one by depressing the right arrow key while in main operate screen. Depress tramline key to toggle from manual to automatic mode.
	RSO module not powered (no indicator light on label)	RSO module harness must be connected to console control (6-pin) connector at hitch <u>and</u> battery (2-pin) connector at hitch
	RSO module not communicating with console (fast blink)	RSO module harness must be connected to console (6-pin) connector at hitch
Row failure or Hi/Lo Alarm on row planting properly	Solenoid or clutch use frame for return connection (ground)	Clutches or solenoids must connect both wires to RSO connector. Frame cannot be used to supply electrical return (ground) connection.
	Seed sensor coated with dirt	Clean sensor using a dry bottle brush.
Row failure or Hi/Lo Alarm on row planting properly	Defective sensor or harness	Trigger sensor and observe troubleshooting LED. If sensor does not have LED, swap harness connection with adjacent sensor to determine if sensor or harness is damaged.

# PM500 OPERATOR'S MANUAL



<p>Hopper alarm does not sound when hopper is empty</p>	<p>Hopper sensor coated with dirt</p> <p>Defective sensor or harness shorted to ground</p> <p>Defective console</p>	<p>Clean sensor using a dry bottlebrush.</p> <p>Swap harness connection with another sensor to determine if sensor or harness is damaged. Use service screen if another sensor is not available. Replace sensor or repair harness.</p> <p>Console is damaged. Contact your dealer, DICKEY-john Europe (011-33-141-192189), or DICKEY-john USA (1-800-637-3302).</p>
<p>Hopper alarm when hopper is full</p>	<p>Defective sensor or harness open</p> <p>Defective console</p>	<p>Swap harness connection with another sensor to determine if sensor or harness is damaged. Use service screen if another sensor is not available. Replace sensor or repair harness.</p> <p>Console is damaged. Contact your dealer, DICKEY-john Europe (011-33-141-192189), or DICKEY-john USA (1-800-637-3302).</p>
<p>System voltages alarm</p>	<p>Low battery voltage</p> <p>Poor battery connection</p> <p>Damaged harness</p>	<p>Console voltage must be at least 10V. If low, recharge or replace battery.</p> <p>Assure connections are clean and tight. Inspect harness for damage.</p> <p>Check all harnesses for pinches or breaks that may cause power or 8V sensor power short to ground.</p>
<p>Tramline configuration alarm</p>	<p>Tramline configuration may be incorrect</p>	<p>Tramline configuration has defined rows that are not activated in the row I/O section. Assure screen definitions correspond properly with harness labels.</p>
<p>Row I/O configuration Alarm</p>	<p>Sensor failure</p> <p>Row I/O configuration may be incorrect</p> <p>Defective console</p>	<p>Console detected a different number of sensors than the Row I/O configuration. Assure all rows are detected during self-test. Replace defective sensors.</p> <p>Console detected a different number of sensors than the Row I/O configuration. Assure detected sensors match row I/O</p> <p>Console is damaged. Contact your dealer, DICKEY-john Europe (011-33-141-192189), or DICKEY-john USA (1-800-637-3302).</p>
<p>Accessory alarm sounding when shaft, fan, or flow is working</p>	<p>Sensor failure</p>	<p>Shaft, fan, or flow sensor not operating. Replace defective sensors.</p>

# PM500 OPERATOR'S MANUAL



	<p>Wrong calibration number</p> <p>Incorrect limits</p> <p>Defective console</p>	<p>Sensor calibration number is incorrect. Check calibration number in accessory setup screen.</p> <p>Sensor limits are incorrect. Check limits in accessory setup screen.</p> <p>Console is damaged. Contact your dealer, DICKEY-john Europe (011-33-141-192189), or DICKEY-john USA (1-800-637-3302).</p>
Ground speed lost Alarm	<p>Ground speed sensor failure</p> <p>Console failure</p>	<p>No ground speed sensor is detected or planting is detected on at least one row with no ground speed.</p> <p>Console is damaged. Contact your dealer, DICKEY-john Europe (011-33-141-192189), or DICKEY-john USA (1-800-637-3302).</p>
Ground speed high alarm sounding	<p>Ground speed alarm set too low</p> <p>Incorrect ground speed constant</p>	<p>Set ground speed alarm limit higher or to zero to disable.</p> <p>Ground speed sensor has not been calibrated, RADAR sensor angle has changed, or incorrect sensor constant is entered. Use SPEED-AREA-DISTANCE mode to determine if speed is correct. If incorrect, recalibrate speed constant (SPEED SETUP SCREEN).</p>
Self-test Alarm	Console failure	Console is damaged. Contact your dealer, DICKEY-john Europe (011-33-141-192189), or DICKEY-john USA (1-800-637-3302).

# PM500 OPERATOR'S MANUAL



## 13 PLANTER AND TRAMLINING CONFIGURATIONS

Many planter and tramlining configurations are supported by the PM500 (refer to figure 25). Selecting a pre-programmed planter configuration provides easy set-up of planter row width, implement width, row types, and number of rows.

Selecting a pre-programmed tramlining configuration provides easy set-up of number of bouts, bout configurations, and RSO assignments. This requires the operator to select from a menu that includes several popular configurations. The configurations define the number of rows, row spacing, sprayer width, and tire spacing. For example, an 8-row planter with 30cm spacing and a 20m sprayer with 3m tire spacing would be entered as:

**08 – 30 – 20 - 03**

Figure 20. Tramline Configurations

Tramline Configuration	Description	Number of bouts	Bout number / Shut-off row(s)
12-45-27-1,8	12-row planter with 45cm spacing and a 27m sprayer with 1,8m tire spacing	5	3 / 5 & 9
12-45-32,4-2.25	12-row planter with 45cm spacing and a 32,4m sprayer with 2.25m tire spacing	6	3 / 10 4 / 10
12-45-37,8-2.25	12-row planter with 45cm spacing and a 37,8m sprayer with 2.25m tire spacing	7	4 / 4 & 9
12-45-43,2-2.25	12-row planter with 45cm spacing and a 43,2m sprayer with 2.25m tire spacing	8	4 / 3 5 / 3
12-45-48,6-2.25	12-row planter with 45cm spacing and a 48,6m sprayer with 2.25m tire spacing	9	5 / 4 & 9
12-50-24-2	12-row planter with 50cm spacing and a 24m sprayer with 2m tire spacing	4	2 / 2 3 / 3
12-50-30-2	12-row planter with 50cm spacing and a 30m sprayer with 2m tire spacing	5	3 / 5 & 9
12-50-36-2.5	12-row planter with 50cm spacing and a 36m sprayer with 2.5m tire spacing	6	3 / 10 4 / 10
12-50-42-2.5	12-row planter with 50cm spacing and a 42m sprayer with 2.5m tire spacing	7	4 / 4 & 9
12-50-48-2.5	12-row planter with 50cm spacing and a 48m sprayer with 2.5m tire spacing	8	4 / 3 5 / 3

*Caution: The default ground speed calibration number (1085) is not modified by the planter configuration. Typically, a ground speed calibration is required for proper system operation. Refer to the Speed Set-up screen (section 6).*



# PM500 OPERATOR'S MANUAL



## 14 CONNECTOR PIN-OUTS

### CONSOLE

#### BATTERY

Pin label	Description
Red wire	Battery +12V
Black wire	Battery ground

#### GROUND SPEED

Pin label	Description
1	Ground (black)
2	Signal (green)
3	Power (red)
4	Sense (white)

#### RSO CONTROL (CAN)

Pin label	Description
A	CAN ground (green)
B	CAN Lo (white)
C	CAN Hi (orange)
D	Plug
E	+12V switched power (red)
F	Return (black)

#### IMPLEMENT

Pin label	Description
1	Row 1 (green)
2	Row 2 (brown)
3	Row 3 (blue)
4	Row 4 (orange)
5	Row 5 (yellow)
6	Row 6 (violet)
7	Row 7 (gray)
8	Row 8 (pink)
9	Row 9 (tan)
10	Row 10 (white/black)
11	Row 11 (red/black)
12	Row 12 (green/black)
13	Left marker (orange/black)
14	Right marker (blue/black)
15	Flow (black/white)

# PM500 OPERATOR'S MANUAL



16	Fan (red/white)
17	
18	
19	
20	
21	
22	
23	
24	8V sensor power (red)
25	8V sensor power (red/black/white)
26	Sensor return (black)
27	Sensor return (white/black/red)
28	
29	Hopper 1 (green/white)
30	Hopper 2 (blue/white)
31	Shaft / Fan (black/red)
32	8V power (red)
33	12V switched power (white/red)
34	12V return (black)
35	
36	
37	Lift switch (orange/red)

## RSO HARNESS

### POWER (HITCH)

Pin label	Description
A	Battery +12V
B	Battery ground

### RSO CONTROL (HITCH)

Pin label	Description
A	CAN ground (green)
B	CAN Lo (white)
C	CAN Hi (orange)
D	Plug
E	+12V switched power (red)
F	Return (black)

### RSO MODULE (GREY CONNECTOR BODY)

Pin label	Description
1	RSO 8 (green)
2	RSO 6 (brown)

# PM500 OPERATOR'S MANUAL



3	RSO 5 (blue)
4	RSO 7 (orange)
5	Battery + (yellow)
6	Battery – (violet)
7	Battery – (gray)
8	Battery + (pink)
9	RSO 3 (tan)
10	RSO 1 (white/black)
11	RSO 2 (red/black)
12	RSO 4 (green/black)

## RSO MODULE (BLACK CONNECTOR BODY)

Pin label	Description
1	RSO 11 (green)
2	RSO 9 (brown)
3	CAN hi (blue)
4	
5	
6	Switched 12V (orange)
7	Switched 12V return (yellow)
8	
9	
10	CAN lo (violet)
11	RSO 10 (gray)
12	RSO 12 (pink)

## RSO CLUTCHES (ROWS 1,2,5,6)

Pin label	Description
A	High side (+V <sub>batt</sub> active)
B	Ground

## RSO CLUTCHES (ROWS 3,4,7,8,9,10,11,12)

Pin label	Description
A	+V <sub>batt</sub>
B	Low side (Ground active)

## RSO POWER HARNESS (BATTERY TO HITCH)

### BATTERY

Pin label	Description
Red wire	Battery + (+V <sub>batt</sub> )
Black wire	Battery – (ground)

# PM500 OPERATOR'S MANUAL

---



## HITCH

<b>Pin label</b>	<b>Description</b>
A	Battery +12V
B	Battery ground

# PM500 OPERATOR'S MANUAL



## 15 PARTS AND WARRANTY INFORMATION

PM500 Service parts					
Monitor		Planter Harnesses & Extensions		Accessory Harnesses	
PM 500 Monitor	46799-0500	4 row harness	46794-0540	Accessory breakout harness	46799-0xxx
Mounting bracket	46799-0xxx	6 row harness	46794-0550	Hoppers & Lift Switch harness	46799-0xxx
Fuse, AGC 5A	20112-0005	8 row harness	46794-0560	Hoppers, Lift Switch & Markers harness	46799-0xxx
Quick start card & cling	46799-0xxx	10 row harness	46794-05xx	Hoppers, Lift Switch, Markers, Fan, Shaft, & Flow harness	46799-0xxx
		12 row harness	46794-05xx	RSO Flow adapter harness (rows 9-12)	46799-0xxx
		2m extension harness	46794-0570	RS-232 harness	46799-0xxx

Dealers have the responsibility of calling to the attention of their customers the following warranty prior to acceptance of an order from their customer for any DICKEY-john product.

### DICKEY-john® WARRANTY

DICKEY-john warrants to the original purchaser for use that, if any part of the product proves to be defective in material or workmanship within one year from date of original installation, and is returned to DICKEY-john within 30 days after such defect is discovered, DICKEY-john will (at our option) either replace or repair said part. This warranty does not apply to damage resulting from misuse, neglect, accident, or improper installation or maintenance. Said part will not be considered defective if it substantially fulfills the performance expectations. THE FOREGOING WARRANTY IS EXCLUSIVE AND IN LIEU OF ALL OTHER WARRANTIES OF MERCHANTABILITY, FITNESS FOR PURPOSE, AND OF ANY OTHER TYPE, WHETHER EXPRESS OR IMPLIED. DICKEY-john neither assumes nor authorizes anyone to assume for it any other obligation or liability in connection with said part and will not be liable for consequential damages. Purchaser accepts these terms and warranty limitations unless the product is returned within fifteen days for full refund of purchase price.



## Appendix A. Using the RSO Module with high current devices

The Row Shut-Off (RSO) module was designed with modern solid-state circuitry to provide reliable, cost effective RSO and/or dual-valve actuator drive currents. The module was designed to drive 12 outputs of moderate current under worst-case temperature conditions (up to 1.5A each, 80 °C) for extended periods. If the RSO outputs are used beyond limits, the circuitry will perform a protective thermal shut down, which will automatically reset after cool-down.

**Caution: If the circuitry is repeatedly driven into thermal shutdown, damage may occur that will lead to RSO module failure.**

An in-line relay harness is available for use in high-current designs (see Section 17, Warrantee and Parts Information). If caution is used to distribute drive currents to a maximum of 6A per driver group then the RSO module can drive devices in excess of 1.5A per output.

The 12 outputs are grouped on 4 drivers.

Driver group	RSO outputs	Maximum current
1	1, 2, 3, 4	1.5A per output, 6A total
2	5, 6, 7, 8	1.5A per output, 6A total
3	9, 10	3.0A per output, 6A total
4	11, 12	3.0A per output, 6A total

Each driver group provides two high side and two low side outputs. To support servo valve drive, RSO outputs 9, 10, 11, and 12 are capable of either high or low side output. The RSO output types are defined as:

Driver group	RSO high side outputs	RSO low side outputs
1	1, 2	3, 4
2	5, 6	7, 8
3		9, 10
4		11, 12

The RSO harness provides the solenoid or clutch connection to ground for all outputs with high side drivers. The harness provides the solenoid or clutch connection to +V<sub>batt</sub> for all outputs with low side drivers.

A special flow harness is required to connect RSO outputs 9 & 10 to valve #1 (main shut-off valve) and RSO outputs 11 & 12 to valve #2 (flow level adjustment valve).